



# Opening Solutions

Opening Systems • Hinges • Slides • Metal drawers

**SEBIOR**  
IT ALL STARTS WITH A DREAM





■ **OPENING SYSTEMS .....4**

RPush Opening system ..... 6  
ORBIX Opening system ..... 8  
EXOS Opening system ..... 10  
LIDO & MELO Opening system ..... 12  
LILLI Mini flap flush mount hinge ..... 14  
Reversible Flap/Lid Stay ..... 16

■ **HINGES ..... 18**

RCS Hinges ..... 21  
RCS 105° Hinge ..... 22  
RCS 105° Hinge Gotham ..... 23  
Special angle RCS Hinges ..... 24  
RCS Hinge mounting plates ..... 25  
RCS Hinges for aluminum-framed doors ..... 26  
Stainless steel RCS Hinges ..... 28  
RFF Hinges ..... 30  
Institutional Hinges ..... 32

■ **SLIDES ..... 34**

EV series concealed slides ..... 38  
EVO series synchronized concealed slides ..... 40  
MOMENTUM Push-to-Open concealed slides ..... 42  
XPERT series ball bearing slides ..... 44  
Stainless steel ball bearing slides ..... 46

■ **DRAWER SYSTEMS ..... 48**

908 Drawer system ..... 52  
908 Drawer system components ..... 54  
AXIAL Drawer system ..... 56  
AXIAL Drawer system components ..... 58  
OPTIMIZ-R Drawer system ..... 60  
OPTIMIZ-R Drawer system components ..... 64  
OPTIMIZ-R program with smoked glass drawer sides ..... 66  
DECOVER Decorative covers for OPTIMIZ-R ..... 68  
ORGANIZ-R Drawer organization system ..... 72

# MAKE YOUR EVERYDAY EASIER

3D files  
available /  
CNC programming  
library



## Tested, Certified, and Guaranteed

### Richelieu Functional Hardware with Certified Quality

At Richelieu, performance and durability are at the heart of our commitments. That is why our functional hardware meets the industry's most demanding standards. Subjected to rigorous testing under high-level criteria, Richelieu products are a true mark of quality.

## Excellence Dedicated to Professionals

Tested by independent North American laboratories, Richelieu hinges, slides, and opening systems meet and exceed the standards of the Kitchen Cabinet Manufacturers Association (KCMA). Through precise manufacturing controls and meticulous quality assurance, we guarantee long-lasting performance year after year.

By choosing Richelieu hardware, cabinet makers provide their customers with strong, reliable cabinets built to last.



# OPENING SYSTEMS

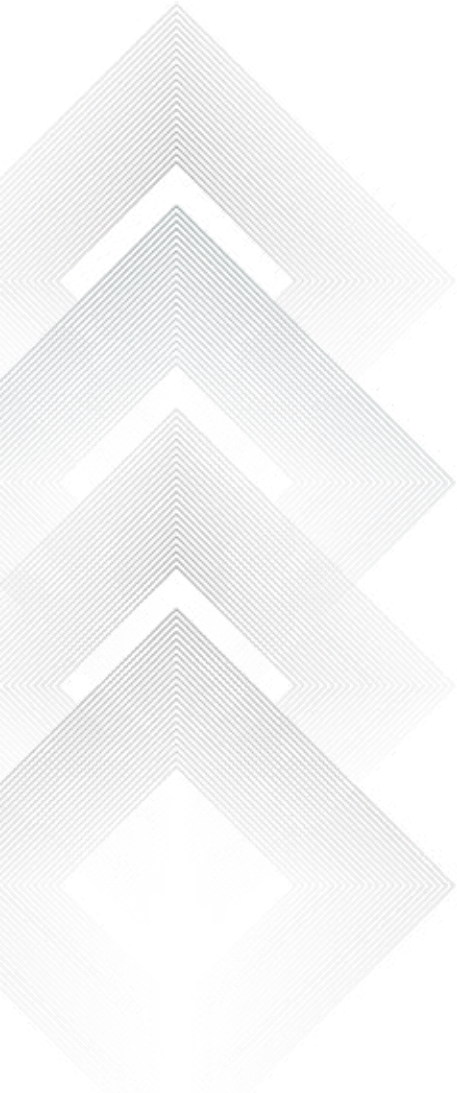

“ Accessibility  
opens up to you. ”



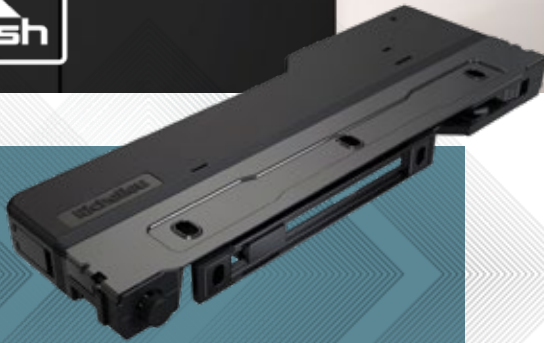

### APPLICATIONS

- Kitchen cabinets
- Pantry cabinets
- Mudroom cabinets
- Wardrobes and closets
- Bathroom storage



See technical details



# RPush

## Opening system









- + Push-to-open 
- Soft-close 

The RPush features a unique assistance arm that fully opens the door when activated by pressure. It operates entirely mechanically, requiring no electrical connection. This innovative device offers a handleless, cable-free, and sleek design, making it a high-end addition that enhances any project and provides a seamless user experience.



## Characteristics

|                  |   |   |   |
|------------------|---|---|---|
| FINISH           |   |   |   |
|                  | Black   | White   |   |
| MOTION           |  |  |  |
|                  | Push-to-open  | Soft-Close  | 100% mechanical   |
|                  | INSTALLATION  |  |  |
| Surface mounting |   | Integrated adjustment   |   |

- + 110° opening angle
- + Assisted opening movement
- + Installs with Free swing hinges RCS32200018 (p. 22)

|          |          |             |       | Door dimensions |          |  |
|----------|----------|-------------|-------|-----------------|----------|--|
| White    | Black    | System Type | Kg    | Height          | Width    |  |
| 118LD030 | 118LD900 | Light duty  | ≤ 7.5 | ≤ 900 mm        | ≤ 600 mm |  |
| 118MD030 | 118MD900 | Medium duty | ≤ 20  | ≤ 2,200 mm      | ≤ 600 mm |  |
| 118HD030 | 118HD900 | Heavy duty  | ≤ 25  | ≤ 2,800 mm      | ≤ 600 mm |  |



When closed, ORBIX presents a sleek and elegant front; when open, ORBIX instantly reveals its contents with a refined presentation.



See technical details



**ORBIX**  
360°



## Rotating opening system

With Orbix, each piece of furniture gains new functionality. This innovative rotating system allows entire elements to spin 360°, seamlessly revealing or concealing the interior. Say goodbye to bulky doors; a simple gesture is all it takes to transform your space and provide full access.

This freedom of movement encourages creative and surprising designs, allowing a single piece of furniture to serve multiple functions.



## Characteristics

MOTION



360°  
rotation



Soft-Close

- + Space Optimization: Enjoy seamless access without bulky doors, featuring two furniture designs in one
- + Unique Experience: Experience an elegant, almost magical movement that transforms the atmosphere of the room
- + Premium Design: Benefit from invisible mechanisms equipped with a soft-close system
- + Multiple Applications: Perfect for use in the kitchen, living/common areas, bathroom, bedroom, and office



## Included

- 2 pivoting mechanisms (top & bottom)
- 4 positioning regulators
- 2 connecting bolts
- Template
- Allen key
- Installation screws

| No.       | Description                   |
|-----------|-------------------------------|
| ORB360400 | ORBIX rotating opening system |

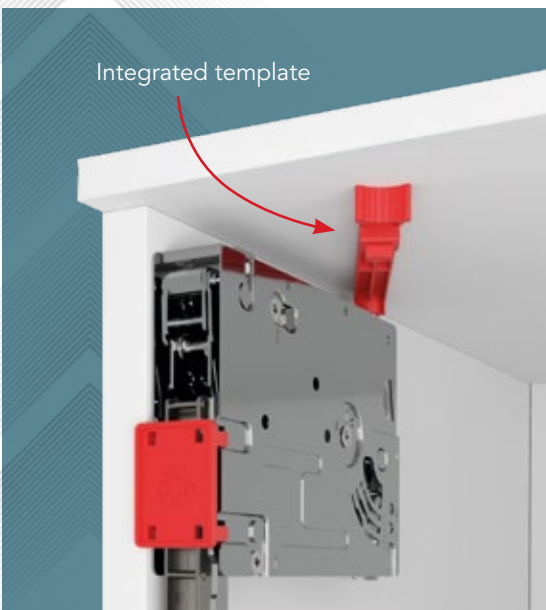

Integrated template

See technical details



# EXOS

## Opening system



The EXOS Opening System from Richelieu is an elegant, efficient solution for upper cabinets. Its hinge-free central mechanism allows a 107° upward opening while maintaining a discreet, seamless integration inside the cabinet.

Easy and quick to install, EXOS requires no templates or specialized tools. Durable and thoughtfully engineered, it blends function, aesthetics, and simplicity for a clean, modern cabinet layout.



**Simplified installation – no more paper templates required! Immediate time savings.**

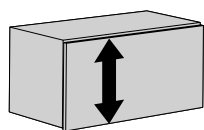

Cabinet height:  
200 - 500 mm

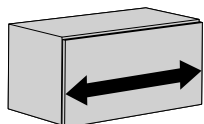

Maximum cabinet width:  
1200 mm

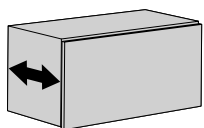

Cabinet depth:  
240 mm +

| Power factor            | White            | Anthracite        |
|-------------------------|------------------|-------------------|
| Light (500-1225)        | <b>EX00LD30</b>  | <b>EX00LD100</b>  |
| Medium (1226-3775)      | <b>EX00MD30</b>  | <b>EX00MD100</b>  |
| Heavy (2126-3775)       | <b>EX00HD30</b>  | <b>EX00HD100</b>  |
| Ultra-heavy (3776-5200) | <b>EX00UHD30</b> | <b>EX00UHD100</b> |

CALCULATING THE POWER FACTOR (PF)  
 $PF = CH \times (\text{door weight} + 2 \times \text{handle weight in kg})$   
 Scan the QR code to access our calculator.



## Characteristics

|              |                  |                |                       |
|--------------|------------------|----------------|-----------------------|
| FINISH       |                  |                |                       |
|              | Anthracite       | White          |                       |
| MOTION       |                  |                |                       |
|              | Soft-Close       | Upward opening |                       |
| INSTALLATION |                  |                |                       |
|              | Surface mounting | Without hinges | Integrated adjustment |

- + Opening angle: 107°
- + Stays open in any position
- + Maximum accessibility
- + Easy installation thanks to built-in templates

## Atmos angle limiter

| Angle | No.                |
|-------|--------------------|
| + 75° | <b>EX00ANGLE75</b> |

\*Bag of 20 units



See technical details



# LIDO & MELO

## Opening system



The Melo flap hinge and Lido lift mechanisms are unique works of art that perfectly embody Italian design elegance and artisanal craftsmanship, delivering a result that is both stylish and highly functional. The combination of the flap hinge with upward or downward lift arms is designed for lift-up and drop-down doors, creating a smooth, gentle motion.

Melo's distinctive trapezoidal shape keeps the product discreet while enhancing the overall look of the furniture. The 12-millimeter diameter of the Lido body gives it a sleek silhouette without compromising the strength required for daily use.



## LIDO - Opening arms

| Downward Opening | Length           |                  |                  |
|------------------|------------------|------------------|------------------|
|                  | 164 mm           | 244 mm           | 355 mm           |
|                  | <b>12D164108</b> | <b>12D244108</b> | <b>12D355108</b> |

| Upward Opening | Length              |                     |                     |
|----------------|---------------------|---------------------|---------------------|
|                | 164 mm              | 244 mm              | 355 mm              |
| 50 newtons     | <b>12L16450108</b>  | <b>12L24450108</b>  | -                   |
| 80 newtons     | <b>12L16480108</b>  | <b>12L24480108</b>  | <b>12L35580108</b>  |
| 100 newtons    | <b>12L164100108</b> | <b>12L244100108</b> | <b>12L355100108</b> |
| 120 newtons    | <b>12L164120108</b> | <b>12L244120108</b> | <b>12L355120108</b> |
| 140 newtons    | -                   | <b>12L244140108</b> | -                   |
| 160 newtons    | -                   | <b>12L244160108</b> | -                   |
| 180 newtons    | -                   | <b>12L244180108</b> | -                   |

**LIDO Adapter for upward and downward opening aluminum door**



Door width: max. 20 mm  
**12DAL20G**



Door width: min. 40 mm  
**12DAL40G**

## Characteristics

|              |  |          |
|--------------|--|----------|
| FINISH       |  | Titanium |
| MOTION       |  |          |
| INSTALLATION |  |          |

- + ± 3 mm adjustment
- + Smooth opening movement
- + Reduced body diameter of 12 mm
- + Compatible with push-to-open systems

## MELO flap hinge



| No.             | Description                      | Finish |
|-----------------|----------------------------------|--------|
| <b>11126180</b> | MELO flap hinge                  | Nickel |
| <b>11128180</b> | MELO Adaptor set (2 mm and 4 mm) | Nickel |

## Characteristics

- + 26-mm Ø space-saving design
- + Built-in adjustment for a flawless finish
- + Fits multiple material thicknesses

The Melo hinge offers the flexibility of installation on different thicknesses of doors and cabinets, ranging from 18 to 20 mm using the adaptors available for this purpose.

**No. 11128180**

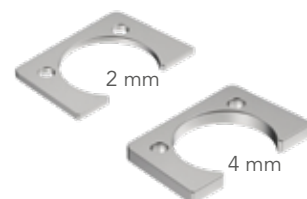



MADE IN ITALY

# LILLI

## Mini flap flush mount hinge





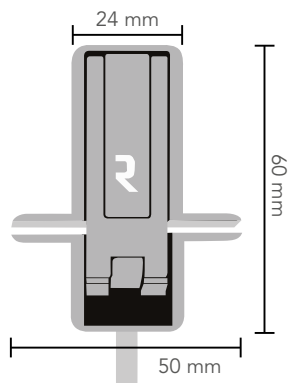

Thanks to its lilliputian size, Lilli is the most discreet flap hinge on the market. Lilli features a streamlined design for completely recessed installation, guaranteeing full, unfettered use of the hinged surface. Achieve an impeccable finish and an unmarred aesthetic on all your hinged furniture with this minimalist piece of hardware that makes the functional elegant.

See technical details





## Characteristics

|              |   |
|--------------|---|
| FINISH       | <br>Nickel   |
| MOTION       | <br>90° opening angle  |
| INSTALLATION |  <br>Integrated adjustment      Recessed mounting |

- + **Minimalist design:** Lilli is discreet and recesses fully into its panel, for seamless, invisible integration.
- + **100% unfettered access:** once the flap is open, no hinge mechanism is visible, making every inch of space useable and ensuring a clean and streamlined aesthetic for your furniture.
- + **High performance:** despite its small size, Lilli is a strong hinge with exceptional longevity.
- + **Versatility:** Lilli is suitable for a wide range of materials and furniture designs.

| No.      | Description      | Finish |
|----------|------------------|--------|
| 10026180 | Lilli flap hinge | Nickel |



## Reversible Flap/Lid Stay

This versatile Richelieu opening arm serves as a lid stay and a flap stay, providing a flexible solution for your cabinetry needs.

Its compact design ensures minimal space is needed inside the cabinet, making it an ideal choice for optimizing storage areas. It features a wear-resistant friction coupling and a wide adjustment range to accommodate various applications.









See technical details





## Characteristics

|                  |   |   |   |
|------------------|---|---|---|
| FINISH           |  |  |   |
|                  | Black   | Chrome  |   |
| MOTION           |  |  |  |
|                  | Upward opening  | Downward opening  | Reversible  |
|                  | INSTALLATION  |  |  |
| Surface mounting |   | Tension adjustment  | With hinge  |

## Included

- 1 Stay
- 1 Door attachment
- 1 Cabinet attachment
- 1 Allen key
- 4 Wood screws to anchor the door and cabinet attachments

| No.        | Finish |
|------------|--------|
| BP65130900 | Black  |
| BP65130180 | Chrome |

+ 100° opening angle

+ Reversible

# HINGES



“ Built to last, designed to fit any opening type ”



# PRODUCT CODE COMBINATION

Product code

**RCS32200048**

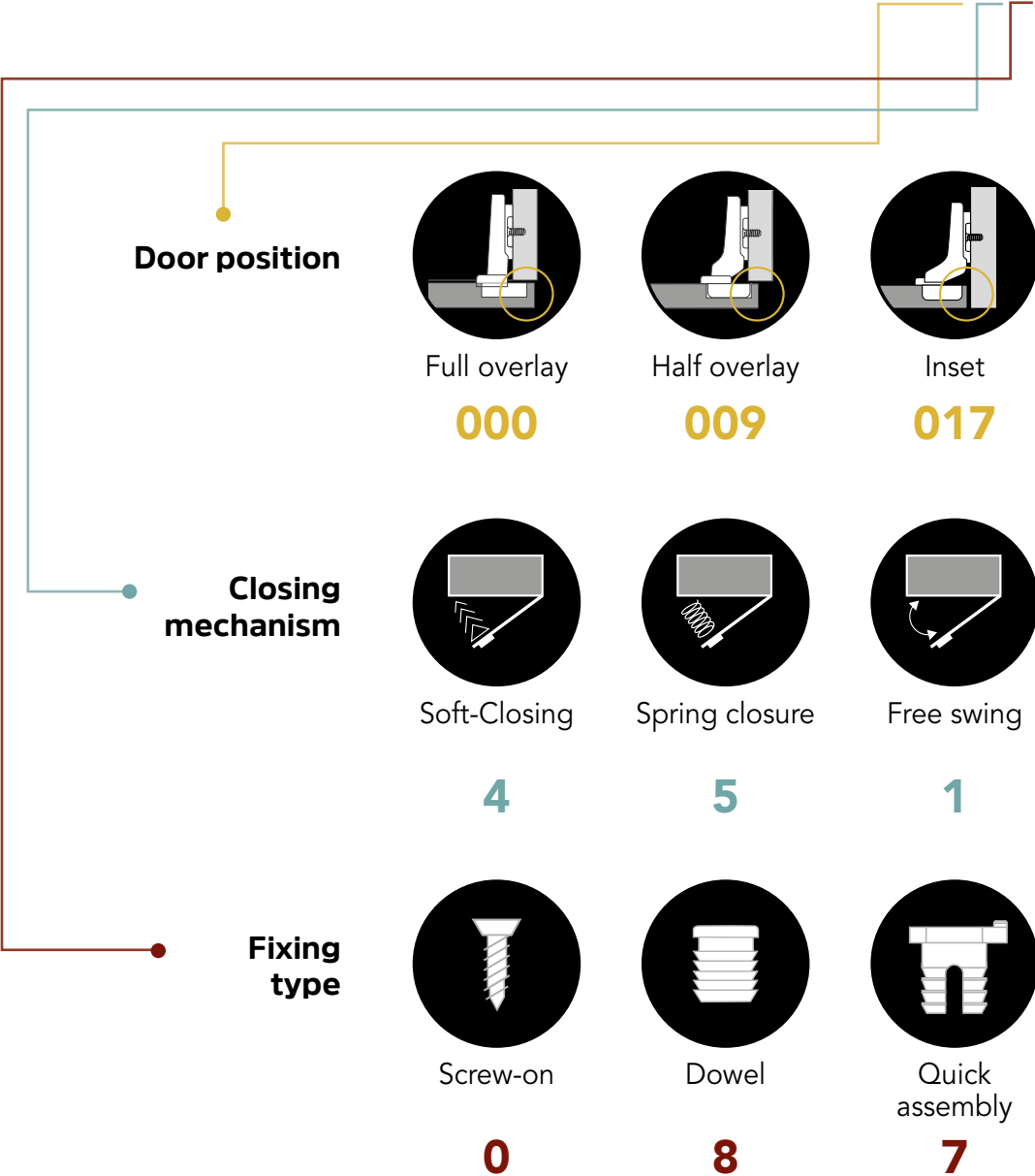



## RCS Hinges

The RCS series features a comprehensive range of hinges, both with and without a soft-closing mechanism. Because these hinges share the same mounting plate, they can be replaced easily. Ingenious and practical, they are also simple to fix and adjust.

See technical details



**Tested and certified**



**Quick to install**



**Adjustable**



**Available**

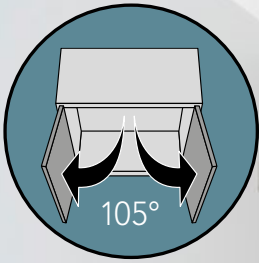

## RCS 105° Hinge

### Characteristics

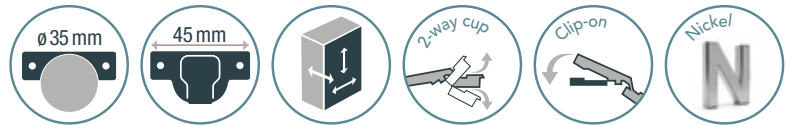

| Door position | Fixing type    | Closing mechanism                        |                    |
|---------------|----------------|--|--------------------|
|               |                | Soft-Closing                             | Spring Closure     |
| Full overlay  | Screw-on       | <b>RCS32200040</b>                       | <b>RCS32200050</b> |
| Full overlay  | Dowel          | <b>RCS32200048</b>                       | <b>RCS32200058</b> |
| Full overlay  | Quick assembly | <b>RCS32200047</b>                       | <b>RCS32200057</b> |
| Half overlay  | Screw-on       | <b>RCS32200940</b>                       | <b>RCS32200950</b> |
| Half overlay  | Dowel          | <b>RCS32200948</b>                       | <b>RCS32200958</b> |
| Half overlay  | Quick assembly | <b>RCS32200947</b>                       | -                  |
| Inset         | Screw-on       | <b>RCS32201740</b>                       | <b>RCS32201750</b> |
| Inset         | Dowel          | <b>RCS32201748</b>                       | <b>RCS32201758</b> |
| Full overlay  | Dowel          | <b>Free Swing</b><br><b>RCS32200018*</b> |                    |



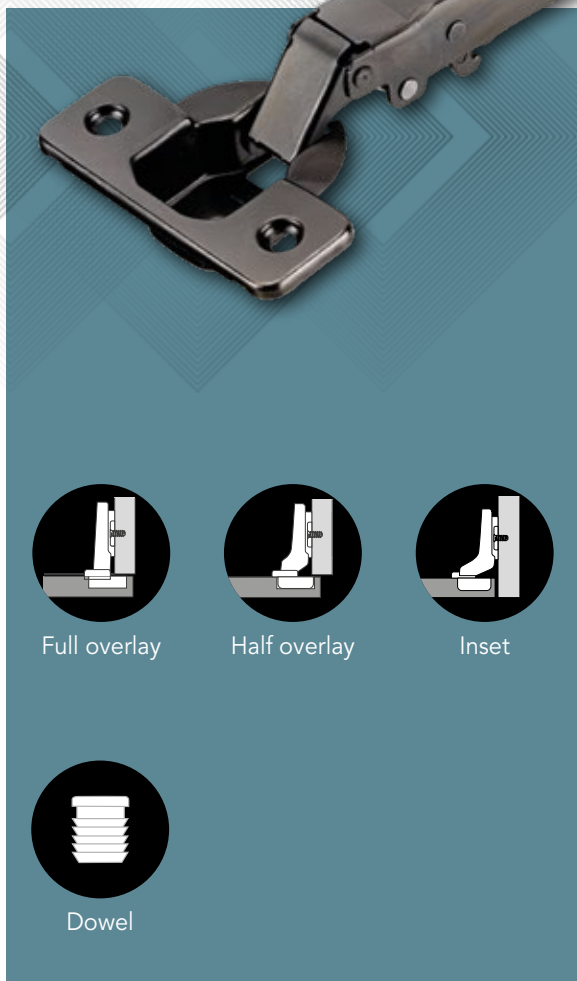
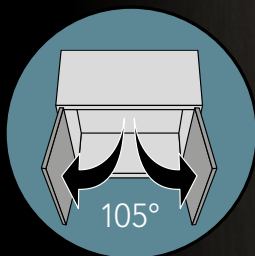

## RCS 105° Hinge Gotham



### Characteristics



Full overlay



Half overlay



Inset



Dowel



Soft-Closing  
mechanism

Door position

Fixing  
type

RCS32200048181

Full overlay

Dowel

RCS32200948181

Half overlay

Dowel

RCS32201748181

Inset

Dowel

### RCS mounting plates

| Height | Screw-on  | Euro screw-on |
|--------|-----------|---------------|
| 0 mm   | RCS00502N | RCS00602N     |
| 2 mm   | RCS00520N | RCS00622181   |



# Special angle RCS Hinges

## Characteristics



### RCS 165° Hinge

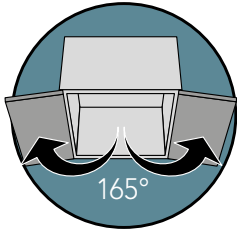

Full overlay

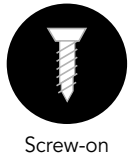

Screw-on

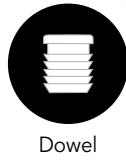

Dowel



| Fixing type | Closing mechanism |                |
|-------------|-------------------|----------------|
|             | Soft-Closing      | Spring Closure |
| Screw-on    | RCS322650040      | -              |
| Dowel       | RCS322650048      | RCS322650058   |

### RCS 65° Bi-fold door hinge (Lazy Susan)



Corner / Bi-Fold

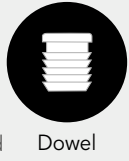

Dowel



| Fixing type |             |
|-------------|-------------|
| Dowel       | RCS35350058 |

### RCS 90° Blind corner hinge

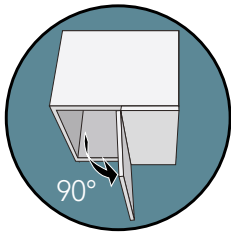

Screw-on

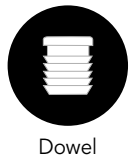

Dowel



| Fixing type | Closing mechanism |                |
|-------------|-------------------|----------------|
|             | Soft-Closing      | Spring Closure |
| Screw-on    | RCS35900040       | -              |
| Dowel       | RCS35900048       | RCS35900058    |

### RCS 45° Hinge

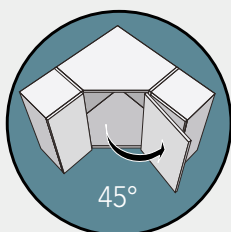

Full overlay

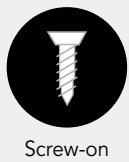

Screw-on

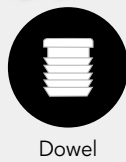

Dowel



| Fixing type | Closing mechanism |                |
|-------------|-------------------|----------------|
|             | Soft-Closing      | Spring Closure |
| Screw-on    | RCS35450040       | -              |
| Dowel       | RCS35450048       | RCS35450058    |



## RCS Hinge mounting plates



Standard

| Height | Screw-on | Euro screw-on | Expando dowels |
|--------|----------|---------------|----------------|
| 0 mm   | RCS00100 | RCS00200      | RCS01700       |
| 2 mm   | RCS00120 | RCS00220      | RCS01702       |
| 4 mm   | RCS00140 | RCS00240      | RCS01704       |

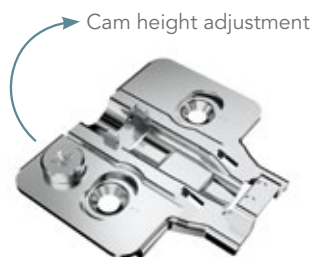

Cam height adjustment

| Height | Screw-on | Euro screw-on | Expando dowels |
|--------|----------|---------------|----------------|
| 0 mm   | RCS00502 | RCS00602      | RCS01007       |
| 2 mm   | RCS00520 | RCS00622      | RCS01027       |
| 4 mm   | RCS00540 | RCS00642      | RCS01047       |

Cam height adjustment

| Height | Screw-on |
|--------|----------|
| 0 mm   | RCS00902 |
| 3 mm   | RCS00930 |
| 6 mm   | RCS00960 |

### Cover caps

Metal square cover for RCS hinge arm  
No. **RCS2695180**



Metal curved cover for RCS hinge arm  
No. **RCS2696180**

### Angle restrictor

89° angle restrictor  
No. **RCSR001P**



### RCS Insertion RAM for concealed RCS hinges

Compatible with every RCS 105° hinges  
No. **RCSRAM01**





## RCS Hinges for aluminum-framed doors

Designed specifically for aluminum-framed doors, their concealed appearance enhances the aesthetics of your cabinets and furniture. The combination of design, functionality, and adjustability establishes them as the industry standard in most applications.

See technical details





## RCS Hinges for aluminum-framed doors

### Characteristics



|   |                |
|---|----------------|
|  Soft-Closing<br>mechanism | Nickel         |
|   | RCS27100040    |
|   | Black Gotham   |
|   | RCS27100040181 |



### Each kit includes:

- 2 aluminum frame hinges
- 2 eccentrically adjustable plates (0 and 2mm)
- 2 covers
- Screws for cup installation



## Stainless steel **RCS** Hinges

These hinges are made of 304 stainless steel, ensuring they look great and function well even in harsh environments. They are ideal for outdoor applications and in areas prone to moisture, such as sink spaces, garages, and cabinets in outdoor kitchens, among others. Additionally, they blend seamlessly with stainless steel appliances and hardware, showcasing a commitment to fine detail.

**See also**

Stainless steel ball bearing slides p. 46

See technical details



Salt spray



Quick



304 Stainless



Anti-corrosion



Full overlay



Screw-on



Dowel



Soft-Closing mechanism

|  | Fixing type    |                |
|--|----------------|----------------|
|  | Screw-on       | Dowel          |
|  | RCS36050040170 | RCS36050048170 |



**Stainless steel  
RCS mounting plates**

| No.         | Height | Fixing type |
|-------------|--------|-------------|
| RCS00100170 | 0 mm   | Screw-on    |
| RCS00120170 | 2 mm   | Screw-on    |







See technical details





## RFF Hinges

Richelieu's face-frame hinges offer cabinet-makers an ideal choice for concealed hinges with both small and large overlays. They provide quick assembly and full adjustment, featuring patented progressive soft-closing technology that prevents slamming doors.

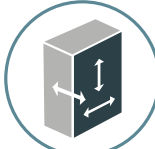
- 

**Tested and certified**
- 

**Adjustment**
- 

**Adjustable Soft-Close**
- 

**Available**



**Progressive Soft-Close**

More precision to adjust your closing mechanism force

**Soft-close damping system**  
for quiet and effortless closing

**6-way adjustments**

Setting for height, side and depth





**Front locating tabs**

Position hinge on face frame

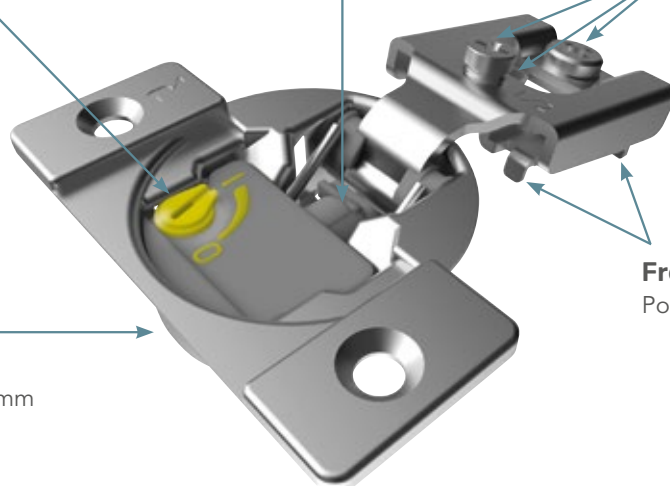
**Low profile cup**

Allows shallow drilling depth of 11 mm



| Closing mechanism  | Overlay | Fixing type  |   |
|--|---------|--|---|
|  |         |  Screw-on |  Dowel |
|  Soft-closing   | 1/2"    | RFF30120040  | RFF30120048   |
|  | 3/4"    | RFF30340040  | RFF30340048   |
|  | 1 1/4"  | RFF31140040  | RFF31140048   |
|  | 1 5/16" | RFF315160040   | RFF315160048  |
|  | 1 3/8"  | RFF31380040  | RFF31380048   |
|  | 1 1/2"  | RFF31120040  | RFF31120048   |
|  Spring closure | 1/2"    | RFF30120050  | RFF30120058   |
|  | 3/4"    | RFF30340050  | RFF30340058   |
|  | 1 1/4"  | RFF31140050  | RFF31140058   |
|  | 1 5/16" | RFF315160050   | RFF315160058  |
|  | 1 3/8"  | RFF31380050  | RFF31380058   |
|  | 1 1/2"  | RFF31120050  | RFF31120058   |

**Angle-restriction device for RFF hinges**

This device easily clips into RFF Hinges, limiting the opening angle to 86°. This prevents cabinet doors from colliding with adjacent walls or other doors when two adjacent doors swing open toward each other. No tools are required.

**No. RFFR001P**





## APPLICATIONS

- Institutional projects
- Hospitals
- Schools
- Commercial applications

# Institutional Hinges



Richelieu's institutional hinge offers robust support and smooth functionality for heavy-duty doors. It's a classic, durable hinge solution suitable for a variety of commercial and residential applications.

Made from high-quality materials, it stands up to frequent use in high-traffic areas, delivering reliable, long-lasting performance.

See technical details





## Characteristics

- + Wide 270° opening
- + 5-knuckle hinge
- + Slotted holes for adjustment
- + 32-mm system for the hole pattern
- + Countersunk hole for #8 screws & euro screws
- + Hospital tips



### Bulk packaging

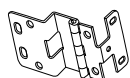

| No.      | Door thickness | Finish              | Qty |
|----------|----------------|---------------------|-----|
| 70122170 | 13/16"         | Stainless steel 304 | 50  |
| 70122145 | 13/16"         | Satin Chrome        | 50  |
| 7012290  | 13/16"         | Black               | 50  |
| 71122145 | 3/4"           | Satin Chrome        | 50  |
| 7112290  | 3/4"           | Black               | 50  |

### 2 hinges and the installation screws kit



| No.        | Door thickness | Finish       | Qty |
|------------|----------------|--------------|-----|
| BP70122145 | 13/16"         | Satin Chrome | 2   |
| BP7012290  | 13/16"         | Black        | 2   |
| BP71122145 | 3/4"           | Satin Chrome | 2   |
| BP7112290  | 3/4"           | Black        | 2   |

# SLIDES



“ The hidden force driving the success of your projects. ”



# UNDERMOUNT SLIDES COMPARATIVE TABLE



**818EV**

**815EV**

**828 EVO**

**825 EVO**

**823 EVO**

|                       | 818EV          | 815EV          | 828 EVO        | 825 EVO        | 823 EVO        |
|-----------------------|----------------|----------------|----------------|----------------|----------------|
| Load capacity         | 35 kg (77 lb)  | 35 kg (77 lb)  | 50 kg (110 lb) | 50 kg (110 lb) | 50 kg (110 lb) |
| Extension             | Full extension | Full extension | Full extension | Full extension | Full extension |
| Closing mechanism     | Soft-closing   | Soft-closing   | Soft-closing   | Soft-closing   | Soft-closing   |
| Synchronized movement |                |                |                |                |                |
| Adjustment            | 4 directions   | 4 directions   | 6 directions   | 6 directions   | 6 directions   |
| Cabinet type          | Frameless      | Face frame     | Frameless      | Face frame     | Face frame     |
| Material thickness    | 16 mm (5/8")   | 16 mm (5/8")   | 16 mm (5/8")   | 16 mm (5/8")   | 19 mm (3/4")   |





Classic

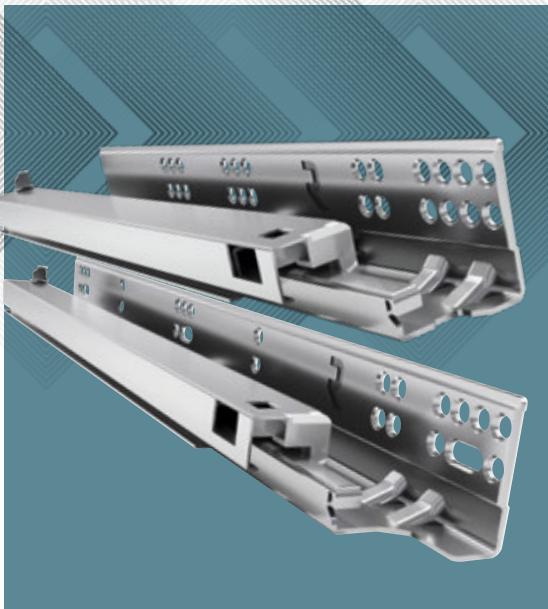

## EV series

### Concealed slides

The EV concealed slides feature full extension and offer both horizontal and height adjustments, ensuring a perfect fit for all your projects. Their smooth and stable sliding mechanism, along with a soft-close function, makes the EV series an ideal choice for various applications. With these slides, drawers in your kitchen, pantry, vanity, or cabinet will open and close effortlessly.

- + Additionally, the side and height adjustments, combined with a front locking device, simplify the installation process.



Tested and certified



Available



## 818EV series slides



Frameless

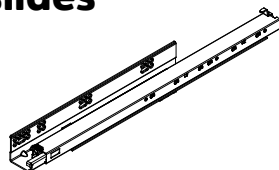

### 818EV

| Length       | For 16 mm (5/8") material |
|--------------|---------------------------|
| 270 mm (10") | <b>818EV270</b>           |
| 300 mm (12") | <b>818EV300</b>           |
| 350 mm (14") | <b>818EV350</b>           |
| 400 mm (16") | <b>818EV400</b>           |
| 450 mm (18") | <b>818EV450</b>           |
| 500 mm (20") | <b>818EV500</b>           |
| 550 mm (22") | <b>818EV550</b>           |

## 815EV series slides



Face frame

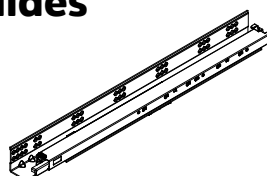

### 815EV

| Length       | For 16 mm (5/8") material |
|--------------|---------------------------|
| 229 mm (9")  | <b>815EV229</b>           |
| 305 mm (12") | <b>815EV305</b>           |
| 381 mm (15") | <b>815EV381</b>           |
| 457 mm (18") | <b>815EV457</b>           |
| 533 mm (21") | <b>815EV533</b>           |

See technical details

818EV



815EV



## Characteristics

|               |   |
|---------------|---|
| LOAD CAPACITY | <b>35 kg (77 lb)</b>  |
| EXTENSION     | Full extension  |
| MOTION        | Soft-Close  |
| ADJUSTMENTS   | <b>4D</b> Adjustable in 4 directions<br><b>Lateral</b><br><b>Vertical</b> |

## Locking devices

An automatic locking device that is easily accessible for removing the drawer and can be adjusted in four directions.



| Side       | 4-way adjustment |
|------------|------------------|
| Right side | <b>8180402</b>   |
| Left side  | <b>8180403</b>   |

## Rear mounting brackets (for 815EV slide)

Attach the drawer slides onto the back panel of the cabinet.

No. 8082G





Premium

**EVO**

NEW  
N

## EVO series

### Synchronized concealed slides

These slides are designed to exceed your expectations, offering the perfect blend of advanced features. They boast a soft-close mechanism, smooth and synchronized movement, and an impressive load capacity of 110 lbs (50 kg). The EVO Series combines strength and reliability to meet demanding industry standards.

- + High-performance smooth motion
- + Elegantly concealed beneath the drawer
- + Easy to open
- + Increased load capacity suitable for a wide range of applications



Tested and certified



Available



**828EVO is a hybrid slide designed for both wooden drawers and our OPTIMIZ-R metal drawer system.**

## 828EVO series slides



Frameless

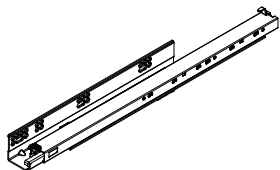

| 828EVO                    |                 |              |                 |
|---------------------------|-----------------|--------------|-----------------|
| For 16 mm (5/8") material |                 |              |                 |
| Length                    | No.             | Length       | No.             |
| 300 mm (12")              | <b>828EV300</b> | 500 mm (20") | <b>828EV500</b> |
| 350 mm (14")              | <b>828EV350</b> | 550 mm (22") | <b>828EV550</b> |
| 400 mm (16")              | <b>828EV400</b> | 600 mm (24") | <b>828EV600</b> |
| 450 mm (18")              | <b>828EV450</b> | 650 mm (26") | <b>828EV650</b> |

## 825EVO and 823EVO series slides



Face frame

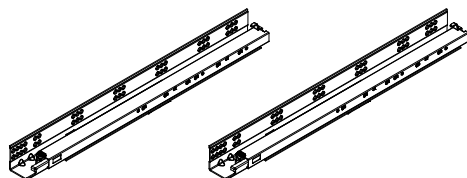

|              | 825EVO                    | 823EVO                    |
|--------------|---------------------------|---------------------------|
|              | For 16 mm (5/8") material | For 19 mm (3/4") material |
|              | 16mm                      | 19mm                      |
| Length       |                           |                           |
| 305 mm (12") | <b>825EV305</b>           | <b>823EV305</b>           |
| 381 mm (15") | <b>825EV381</b>           | <b>823EV381</b>           |
| 457 mm (18") | <b>825EV457</b>           | <b>823EV457</b>           |
| 533 mm (21") | <b>825EV533</b>           | <b>823EV533</b>           |

See technical details

828EVO



825EVO



823EVO



## Characteristics

|               |  |
|---------------|--|
| LOAD CAPACITY | 50 kg (110 lb)   |
| EXTENSION     | Full extension   |
| MOTION        | Soft-Close  Synchronized movement                              |
| ADJUSTMENTS   | Adjustable in 6 directions<br><b>6D</b> Lateral Vertical Depth |

## Locking devices

| Side       | 4-way adjustment | 6-way adjustment |
|------------|------------------|------------------|
| Right side | <b>82XEV402</b>  | <b>82XEV602</b>  |
| Left side  | <b>82XEV403</b>  | <b>82XEV603</b>  |



### Locking devices for narrow drawers

Allows you to build a narrower drawer up to 5 3/4" (145 mm).

| Side       | 2-way adjustment |
|------------|------------------|
| Right side | <b>828NR02</b>   |
| Left side  | <b>828NR03</b>   |



## Rear mounting brackets (for 825EVO & 823EVO slides)

Attach the drawer slides onto the back panel of the cabinet.

No. 8082G





# MOMENTUM

## Push-to-Open concealed slides



### The power of a single touch!

The MOMENTUM Push-to-Open Slide allows for easy opening with just a gentle tap on the drawer front. This unique slide design eliminates the need for handles or knobs, providing a sleek and modern aesthetic for furniture and cabinetry. The spring-loaded mechanism means that a light push on the door activates the slide, causing it to glide open smoothly.

Push-to-open slides are popular in contemporary interior design as a minimalist, user-friendly solution. This innovative hardware is both practical and enhances the overall appearance and functionality of furniture in various settings.

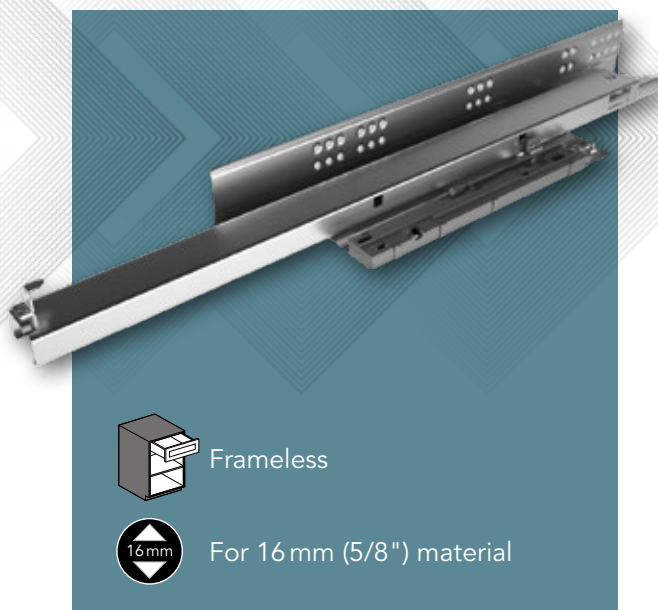

Frameless



For 16 mm (5/8") material



Tested and certified



Available



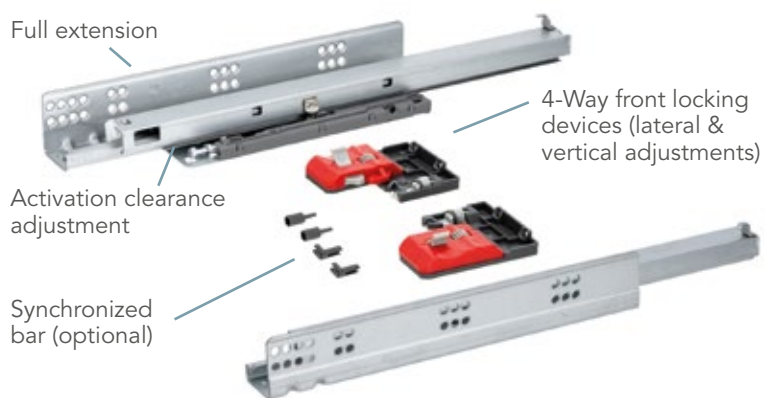

**!**  
**MOMENTUM** slide is designed for both wooden drawers and our **OPTIMIZ-R** metal drawer system.

### Included

- A pair of slides
- A pair of front locking clips
- Optional synchronized rod adaptors

### Momentum slides

| Length       | No.              |
|--------------|------------------|
| 350 mm (14") | <b>8MPUSH350</b> |
| 400 mm (16") | <b>8MPUSH400</b> |
| 450 mm (18") | <b>8MPUSH450</b> |
| 500 mm (20") | <b>8MPUSH500</b> |
| 550 mm (22") | <b>8MPUSH550</b> |

Sold per pair



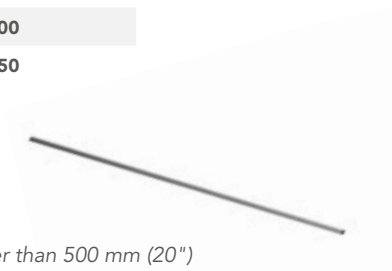

### Optional

Synchronized bar (optional)  
 Recommended for drawers wider than 500 mm (20")

No. **8MPUSH001**



### Characteristics

|               |   |
|---------------|---|
| LOAD CAPACITY | <br>45 kg<br>(100 lb)                              |
| EXTENSION     | <br>Full extension                                 |
| MOTION        | <br>Push-to-open                                   |
| ADJUSTMENTS   |  Adjustable in 4 directions<br>Lateral<br>Vertical |



# XPERT series

## Ball bearing slides

The ultra-fluid movement and minimized opening force make this ball-bearing slide every expert's top choice. Available with or without soft-close, the XPERT series is suitable for all your woodworking projects.

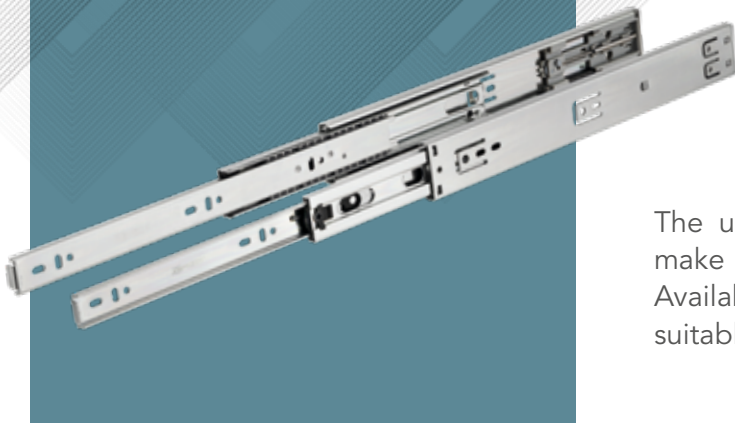

See technical details



Tested and certified



Available





Industrial-grade steel ball bearings







Strong and efficient double spring with silent and smooth piston



A durable and easy-to-use lever disconnect.

## Characteristics

|               |   |
|---------------|---|
| LOAD CAPACITY |  45 kg (100 lb)  |
| EXTENSION     |  Full extension  |
| MOTION        |  Soft-Close  Standard |

- + Made of high-quality cold rolled steel
- + Double spring mechanism offers excellent stability of movement
- + Steel soft-close piston for better resistance

| Length       | Soft-Close  | Standard  |
|--------------|-------------|-----------|
| 300 mm (12") | 45XPSC2G300 | 45XP2G300 |
| 350 mm (14") | 45XPSC2G350 | 45XP2G350 |
| 400 mm (16") | 45XPSC2G400 | 45XP2G400 |
| 450 mm (18") | 45XPSC2G450 | 45XP2G450 |
| 500 mm (20") | 45XPSC2G500 | 45XP2G500 |
| 550 mm (22") | 45XPSC2G550 | 45XP2G550 |
| 600 mm (24") | 45XPSC2G600 | 45XP2G600 |

Rear bracket for Xpert slides  
No. 45XP2G0001



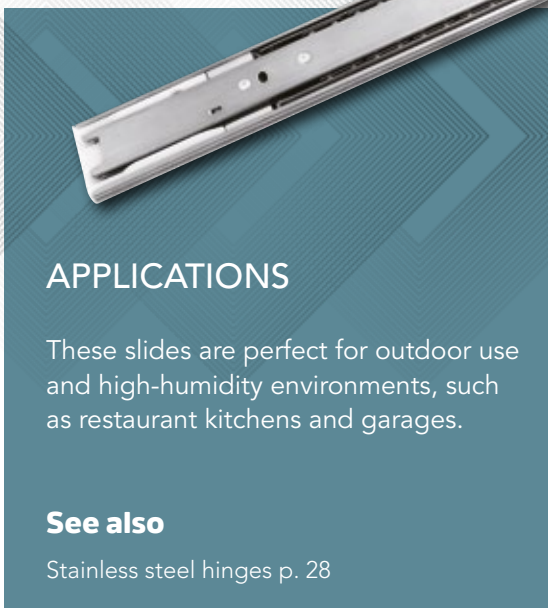

## APPLICATIONS

These slides are perfect for outdoor use and high-humidity environments, such as restaurant kitchens and garages.

### See also

Stainless steel hinges p. 28

See technical details



# Stainless steel

## Ball bearing slides

Constructed from 304 stainless steel, the Richelieu slides retain their appearance and functionality even in the most challenging conditions. The high levels of chromium and nickel in grade 304 stainless steel provide excellent corrosion resistance.

+



304 Stainless steel



Anti-corrosion



Tested and certified



### Characteristics

|               |                |                    |
|---------------|----------------|--------------------|
| LOAD CAPACITY |                |                    |
|               | Soft-Close     | Standard           |
| EXTENSION     |                |                    |
|               | Full extension |                    |
| MOTION        |                |                    |
|               | Soft-Close     | Without Soft-Close |

## 304 series slides

| Length       | Soft-Close  | Without Soft-Close |
|--------------|-------------|--------------------|
| 300 mm (12") | 304SC170300 | -                  |
| 350 mm (14") | 304SC170350 | -                  |
| 400 mm (16") | 304SC170400 | 304170400          |
| 450 mm (18") | 304SC170450 | 304170450          |
| 500 mm (20") | 304SC170500 | 304170500          |
| 550 mm (22") | 304SC170550 | 304170550          |

### Rear support brackets for stainless steel ball bearing slides

No. TU304RB2G



- + Corrosion-resistant
- + Tested for 300 hours in a salt spray environment.
- + Compatible with industry drilling dimensions
- + 45 mm profile



# DRAWER SYSTEMS



“ Optimizing space  
makes life easier. ”

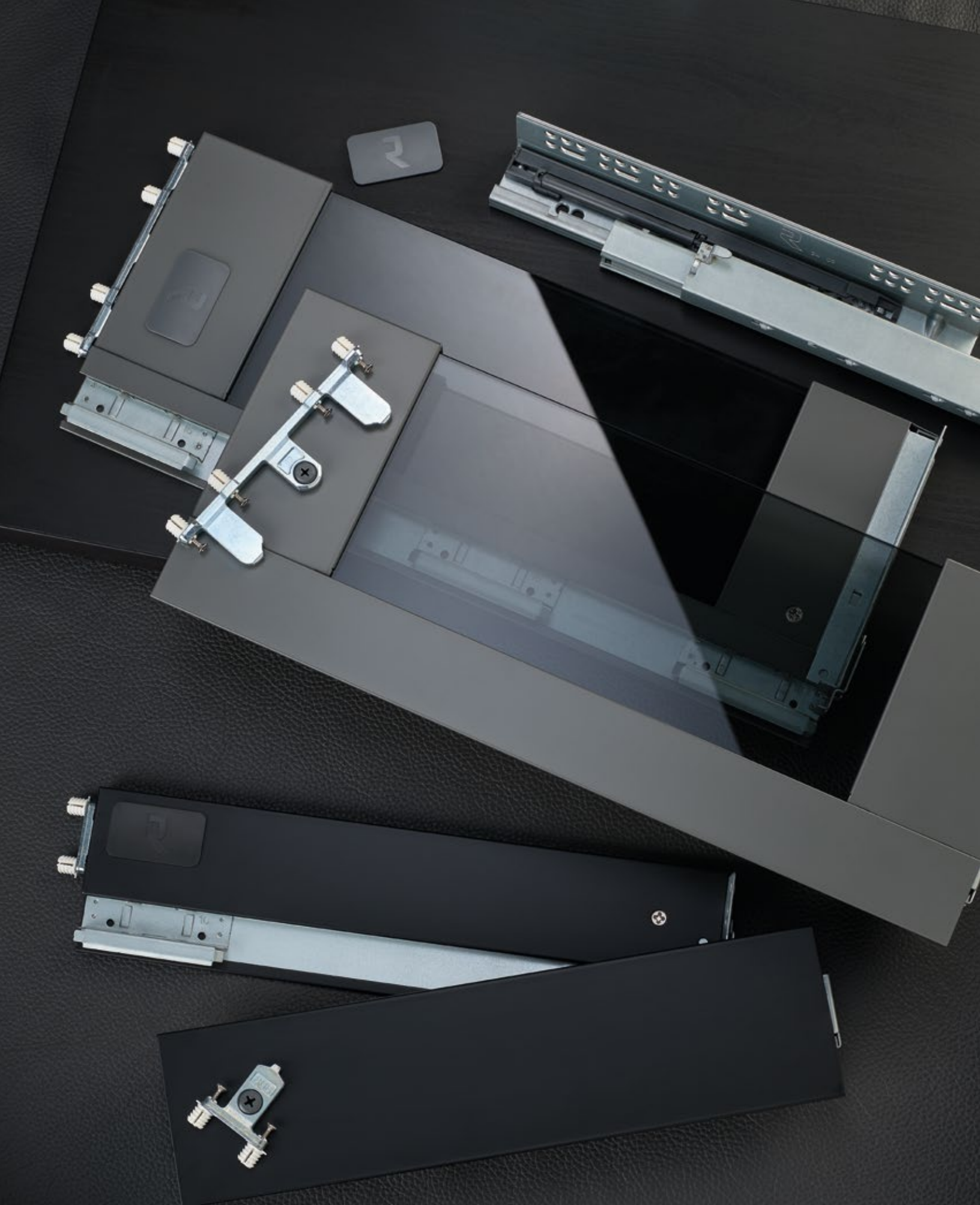

# METAL DRAWERS COMPARATIVE TABLE

|                        | <br><b>908</b>   | <br><b>AXIAL</b>  | <br><b>Optimiz<b>R</b></b>   |
|------------------------|---|--|---|
| Load capacity          | <br><b>35 kg</b><br>(77 lb)   | <br><b>40 kg</b><br>(88 lb)  | <br><b>50 kg</b><br>(110 lb)  |
| Drawer panels          | <br><b>Wide</b>  | <br><b>Slim</b>   | <br><b>Slim</b>  |
| Integrated adjustments |    |   |    |
| Height                 | 1 option<br>(84 mm)   | 4 options<br>(up to 199 mm)  | 4 options<br>(up to 249 mm)   |
| Finish                 |   |   |    |
| Closing mechanism      | <br><b>Soft-Closing</b>  | <br><b>Soft-Closing</b>   | <br><b>Soft-Closing</b>  |





Classic

## 908 Drawer system

The 908 drawer system features advanced dual-synchronizing technology, allowing for smooth and effortless opening. It is built with heavy-duty components capable of supporting up to 35 kg (77 lb), making it the ideal choice for everyday applications.

- + Complete package includes all necessary parts to construct a standard drawer
- + Exceptional performance with a reliable rack and pinion mechanism
- + Available in light gray and white finishes



Wide  
double wall



35 kg  
(77 lb)



Soft-Close



Tested and certified



Available



See technical details

# Reliable and easy to build

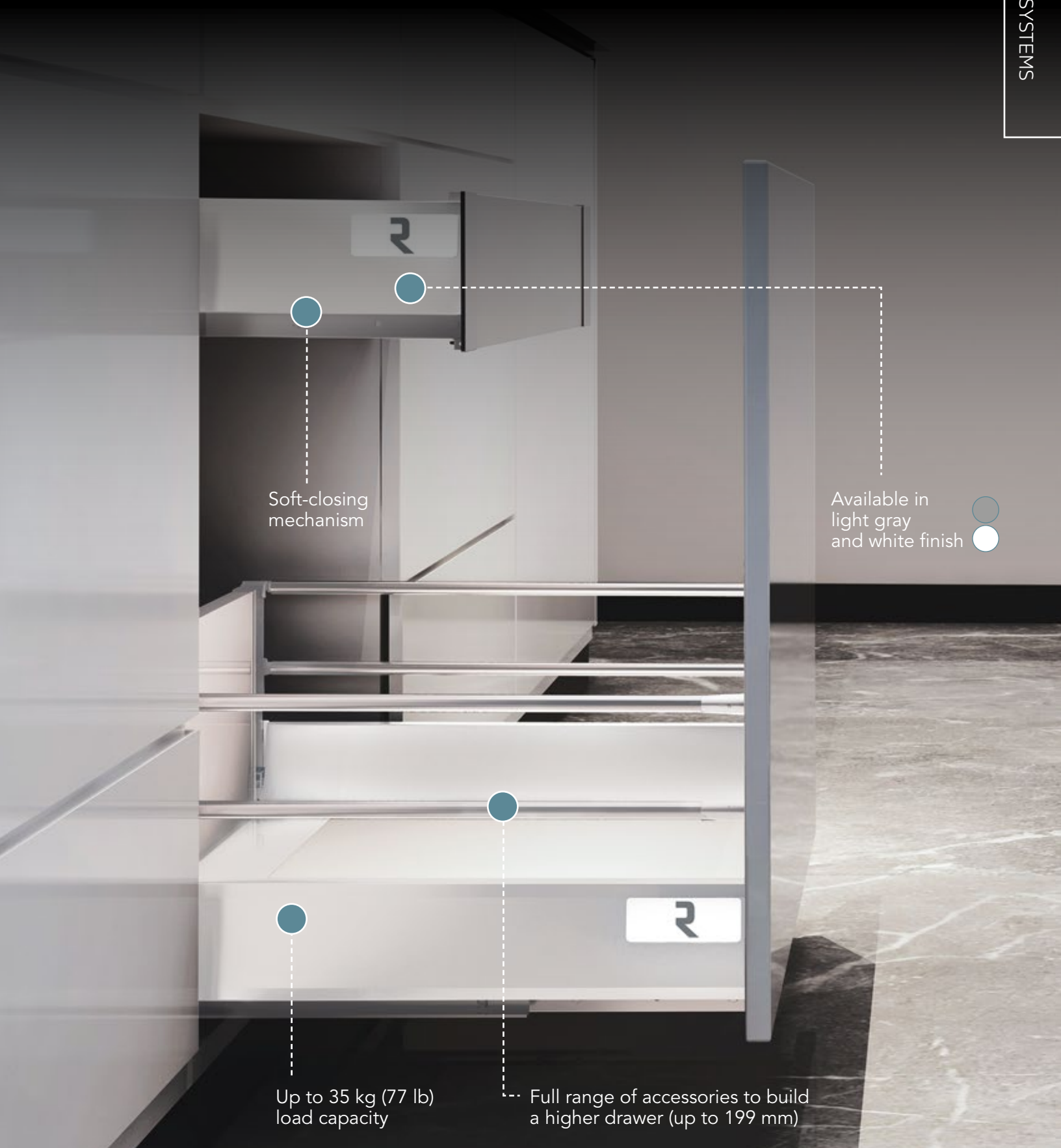

Soft-closing mechanism

Available in light gray and white finish

Up to 35 kg (77 lb) load capacity

Full range of accessories to build a higher drawer (up to 199 mm)



## The kit includes:

- 1 pair of slides (cabinet member)
- 1 pair of wide double wall steel sides (drawer member)
- 1 pair of front brackets with expando dowels
- 1 pair of plastic caps
- 1 pair of rear brackets - maximum drawer height: 3 5/16" (84 mm)

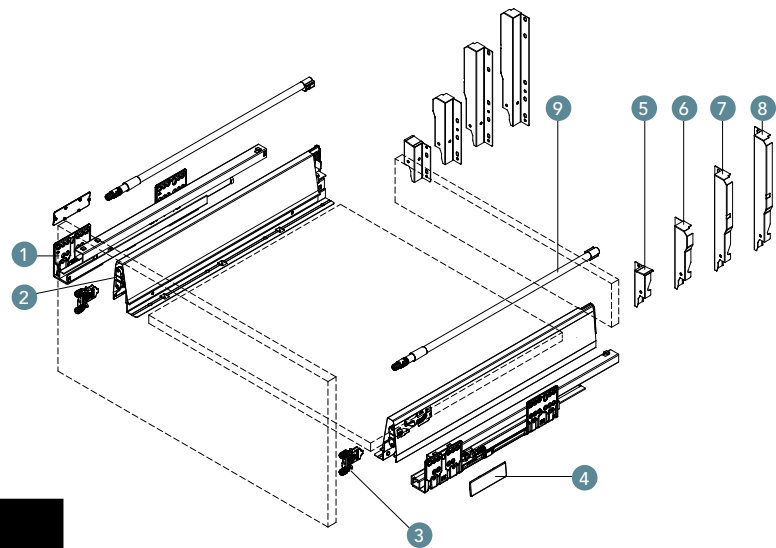

| Drawer nominal length | Internal drawer depth | Min. internal cabinet depth |
|-----------------------|-----------------------|-----------------------------|
| 270 mm (10")          | 244 mm (9 5/8")       | 280 mm (11")                |
| 300 mm (12")          | 274 mm (10 13/16")    | 310 mm (12 3/16")           |
| 350 mm (14")          | 324 mm (12 3/4")      | 360 mm (14 3/16")           |
| 400 mm (16")          | 374 mm (14 3/4")      | 410 mm (16 1/8")            |
| 450 mm (18")          | 424 mm (16 11/16")    | 460 mm (18 1/8")            |
| 500 mm (20")          | 474 mm (18 11/16")    | 510 mm (20 1/16")           |
| 550 mm (22")          | 524 mm (20 5/8")      | 560 mm (22 1/16")           |

## Slides and drawer sides

| Ref.  | Length       | Light gray  | White      |
|-------|--------------|-------------|------------|
| 1 & 2 | 270 mm (10") | 90884270106 | 9088427030 |
|       | 300 mm (12") | 90884300106 | 9088430030 |
|       | 350 mm (14") | 90884350106 | 9088435030 |
|       | 400 mm (16") | 90884400106 | 9088440030 |
|       | 450 mm (18") | 90884450106 | 9088445030 |
|       | 500 mm (20") | 90884500106 | 9088450030 |
|       | 550 mm (22") | 90884550106 | 9088455030 |

## Front brackets

| Ref. | Installation type | No.     |
|------|-------------------|---------|
| 3    | Screw-on          | 908302G |
|      | Dowel             | 908312G |
|      | Expando           | 908322G |

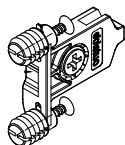

## Cover caps

| Ref. | Description            | Light gray   | White       |
|------|------------------------|--------------|-------------|
| 4    | With Richelieu logo    | BP90810100LE | BP9081030LE |
|      | Without Richelieu logo | 90810100     | 9081030     |

Cover caps can be personalized.  
Ask your Sales representative about the leadtimes and minimum order quantities.

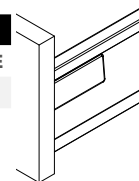

## Rear brackets for deep drawers

| Ref. | Length            | Light gray | White     |
|------|-------------------|------------|-----------|
| 5    | 84 mm (3 5/16")   | 908R084106 | 908R08430 |
| 6    | 135 mm (5 5/16")  | 908R135106 | 908R13530 |
| 7    | 167 mm (6 9/16")  | 908R167106 | 908R16730 |
| 8    | 199 mm (7 27/32") | 908R199106 | 908R19930 |



## Lateral tubes

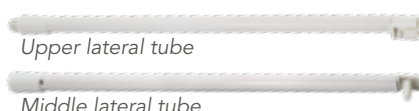

| Ref.                     | Length       | Upper      |           | Middle*    |           |
|--------------------------|--------------|------------|-----------|------------|-----------|
|                          |              | Light gray | White     | Light gray | White     |
| <b>Round tubes</b>       |              |            |           |            |           |
| 9                        | 270 mm (10") | 9084027106 | 908402730 | 9084127106 | 908412730 |
|                          | 300 mm (12") | 9084030106 | 908403030 | 9084130106 | 908413030 |
|                          | 350 mm (14") | 9084035106 | 908403530 | 9084135106 | 908413530 |
|                          | 400 mm (16") | 9084040106 | 908404030 | 9084140106 | 908414030 |
|                          | 450 mm (18") | 9084045106 | 908404530 | 9084145106 | 908414530 |
|                          | 500 mm (20") | 9084050106 | 908405030 | 9084150106 | 908415030 |
|                          | 550 mm (22") | 9084055106 | 908405530 | 9084155106 | 908415530 |
| <b>Rectangular tubes</b> |              |            |           |            |           |
| 9                        | 270 mm (10") | 908T270106 | 908T27030 | 908M270106 | 908M27030 |
|                          | 300 mm (12") | 908T300106 | 908T30030 | 908M300106 | 908M30030 |
|                          | 350 mm (14") | 908T350106 | 908T35030 | 908M350106 | 908M35030 |
|                          | 400 mm (16") | 908T400106 | 908T40030 | 908M400106 | 908M40030 |
|                          | 450 mm (18") | 908T450106 | 908T45030 | 908M450106 | 908M45030 |
|                          | 500 mm (20") | 908T500106 | 908T50030 | 908M500106 | 908M50030 |
|                          | 550 mm (22") | 908T550106 | 908T55030 | 908M550106 | 908M55030 |

\*Needed for 199 mm height only

## Double lateral panels

Work with round upper tubes only.

| Length       | Light gray   | White       |
|--------------|--------------|-------------|
| 270 mm (10") | 908199227106 | 90819922730 |
| 300 mm (12") | 908199230106 | 90819923030 |
| 350 mm (14") | 908199235106 | 90819923530 |
| 400 mm (16") | 908199240106 | 90819924030 |
| 450 mm (18") | 908199245106 | 90819924530 |
| 500 mm (20") | 908199250106 | 90819925030 |
| 550 mm (22") | 908199255106 | 90819925530 |

## Inner drawer components

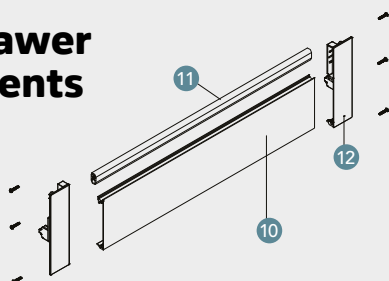

## Front panels

(can be cut to size)

| Ref. | Length             | Light gray   | White       |
|------|--------------------|--------------|-------------|
| 10   | 1,100 mm (43 1/4") | 908FP1100106 | 908FP110030 |



## Rectangular front rails

Length: 1,100 mm

| Ref. | Description | Light gray   | White       |
|------|-------------|--------------|-------------|
| 11   | Rectangular | 908RT1100106 | 908RT110030 |
|      | Oval        | 908FR1100106 | 908FR110030 |

## Front brackets

| Ref. | Height            | Light gray   | White       |
|------|-------------------|--------------|-------------|
| 12   | 84 mm (3 5/16")   | 908FPC084100 | 908FPC08430 |
|      | 135 mm (5 5/16")  | 908FPC135100 | 908FPC13530 |
|      | 199 mm (7 27/32") | 908FPC199100 | 908FPC19930 |





# AXIAL

## Drawer system

The AXIAL metal drawer features sleek double panels characterized by straight and symmetrical lines. Its simple, stylish, and timeless design makes the AXIAL drawer an excellent choice for all your woodworking projects. The slim drawer panels provide maximum storage space and are available in a variety of finishes to match your decor perfectly.

- + Finishes available: white and anthracite
- + Easy and straightforward assembly: does not require a locking device
- + Sold as a kit

See technical details



Slim double wall



40 kg  
(88 lb)



Soft-Close



Tested and certified



Available



# Modern, right-angled, and sophisticated concept



Perfect movement:  
soft-close and opening  
with gears for  
unmatched stability

Available in  
dark gray and  
white finish

13 mm slim double panels

40 kg (88 lb)  
load capacity

# AXIAL

## Products included

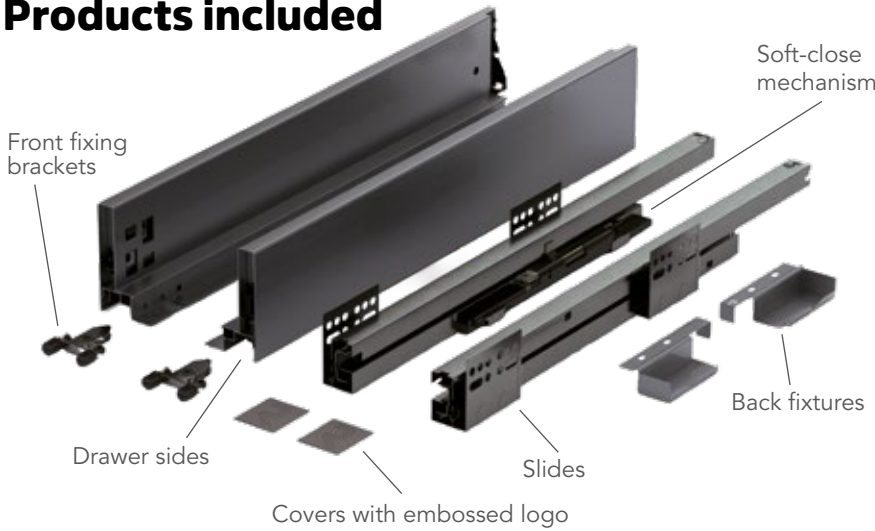

| Drawer nominal length |       | Internal drawer depth | Min. internal cabinet depth |
|-----------------------|-------|-----------------------|-----------------------------|
| 250 mm                | (10") | 240 mm                | 253 mm                      |
| 300 mm                | (12") | 290 mm                | 303 mm                      |
| 350 mm                | (14") | 340 mm                | 353 mm                      |
| 400 mm                | (16") | 390 mm                | 403 mm                      |
| 450 mm                | (18") | 440 mm                | 453 mm                      |
| 500 mm                | (20") | 490 mm                | 503 mm                      |
| 550 mm                | (22") | 540 mm                | 553 mm                      |
| 600 mm                | (24") | 590 mm                | 603 mm                      |

|             | Length                           | Anthracite   | White       |
|-------------|----------------------------------|--------------|-------------|
| <b>H84</b>  | Drawer height: 84 mm (3 5/16")   |              |             |
|             | 250 mm (10")                     | AXL84250100  | AXL8425030  |
|             | 300 mm (12")                     | AXL84300100  | AXL8430030  |
|             | 350 mm (14")                     | AXL84350100  | AXL8435030  |
|             | 400 mm (16")                     | AXL84400100  | AXL8440030  |
|             | 450 mm (18")                     | AXL84450100  | AXL8445030  |
|             | 500 mm (20")                     | AXL84500100  | AXL8450030  |
|             | 550 mm (22")                     | AXL84550100  | AXL8455030  |
| <b>H116</b> | Drawer height: 116 mm (4 9/16")  |              |             |
|             | 300 mm (12")                     | AXL116300100 | AXL11630030 |
|             | 350 mm (14")                     | AXL116350100 | AXL11635030 |
|             | 400 mm (16")                     | AXL116400100 | AXL11640030 |
|             | 450 mm (18")                     | AXL116450100 | AXL11645030 |
|             | 500 mm (20")                     | AXL116500100 | AXL11650030 |
|             | 550 mm (22")                     | AXL116550100 | AXL11655030 |
|             | 600 mm (24")                     | AXL116600100 | AXL11660030 |
| <b>H167</b> | Drawer height: 167 mm (6 9/16")  |              |             |
|             | 300 mm (12")                     | AXL167300100 | AXL16730030 |
|             | 350 mm (14")                     | AXL167350100 | AXL16735030 |
|             | 400 mm (16")                     | AXL167400100 | AXL16740030 |
|             | 450 mm (18")                     | AXL167450100 | AXL16745030 |
|             | 500 mm (20")                     | AXL167500100 | AXL16750030 |
|             | 550 mm (22")                     | AXL167550100 | AXL16755030 |
|             | 600 mm (24")                     | AXL167600100 | AXL16760030 |
| <b>H199</b> | Drawer height: 199 mm (7 27/32") |              |             |
|             | 300 mm (12")                     | AXL199300100 | AXL19930030 |
|             | 350 mm (14")                     | AXL199350100 | AXL19935030 |
|             | 400 mm (16")                     | AXL199400100 | AXL19940030 |
|             | 450 mm (18")                     | AXL199450100 | AXL19945030 |
|             | 500 mm (20")                     | AXL199500100 | AXL19950030 |
|             | 550 mm (22")                     | AXL199550100 | AXL19955030 |
|             | 600 mm (24")                     | AXL199600100 | AXL19960030 |



### AXIAL marking jig

| No.       | Drawer height |
|-----------|---------------|
| AXLJIG000 | 84 to 199 mm  |



### Front rails

| Length       | Anthracite | White     |
|--------------|------------|-----------|
| 250 mm (10") | AXL250R100 | AXL250R30 |
| 300 mm (12") | AXL300R100 | AXL300R30 |
| 350 mm (14") | AXL350R100 | AXL350R30 |
| 400 mm (16") | AXL400R100 | AXL400R30 |
| 450 mm (18") | AXL450R100 | AXL450R30 |
| 500 mm (20") | AXL500R100 | AXL500R30 |
| 550 mm (22") | AXL550R100 | AXL550R30 |



### Cover caps

| Description            | Anthracite | White     |
|------------------------|------------|-----------|
| With Richelieu logo    | AXLCAPL100 | AXLCAPL30 |
| Without Richelieu logo | AXLCAP107  | AXLCAP30  |

### Inner drawer components

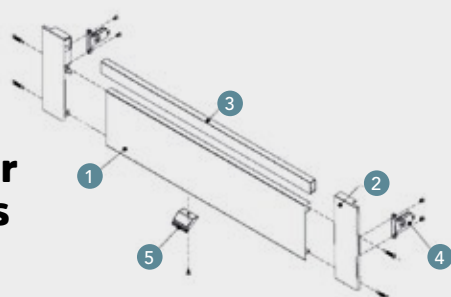

### Front panels

(can be cut to size)

| Ref. | Height            | Anthracite | White    |
|------|-------------------|------------|----------|
| 1    | H84 - H167 - H199 | AXL01F107  | AXL01F30 |
|      | H116              | AXL02F107  | AXL02F30 |



### Front rails



| Ref. | Height             | Anthracite | White    |
|------|--------------------|------------|----------|
| 3    | H116 - H167 - H199 | AXL00F107  | AXL00F30 |

### Front fixing brackets



| Ref. | Height | Anthracite | White     |
|------|--------|------------|-----------|
| 2    | H84    | AXL84C100  | AXL84C30  |
|      | H116   | AXL116C100 | AXL116C30 |
|      | H167   | AXL167C100 | AXL167C30 |
|      | H199   | AXL199C100 | AXL199C30 |

### Front fixing brackets



| Ref. | Height        | Screw-on    | Dowel        |
|------|---------------|-------------|--------------|
| 4    | H84 and H116  | AXLBR84116  | AXLBRD84116  |
|      | H167 and H199 | AXLBR167199 | AXLBRD167199 |

### Additional bottom fixing bracket for AXIAL

\*Optional. Recommended for drawers 28" or wider.



| Ref. No.  |
|-----------|
| 5 AXL0000 |



Premium

# Optimiz<sup>R</sup>

## Drawer system

Discover the OPTIMIZ-R drawer system from Richelieu, featuring slim double panels. This ingenious metal drawer is designed to maximize your storage space with a sleek, streamlined profile. It's easy to install and perfect for all your projects! With its slender and minimalist design, it operates on our 828 series synchronized slide, making it an ideal choice for the cabinet industry.

- + Maximizes storage space with a streamlined design
- + Available finishes: white, anthracite, and matte black
- + Durable solid steel construction
- + Simple and fast assembly (integrated rear brackets, no additional machining required on the drawer bottom)



Slim double wall



50 kg  
(110 lb)



Soft-Close



Tested and certified



Available





# A flawless and aesthetically pleasing result with optimized space

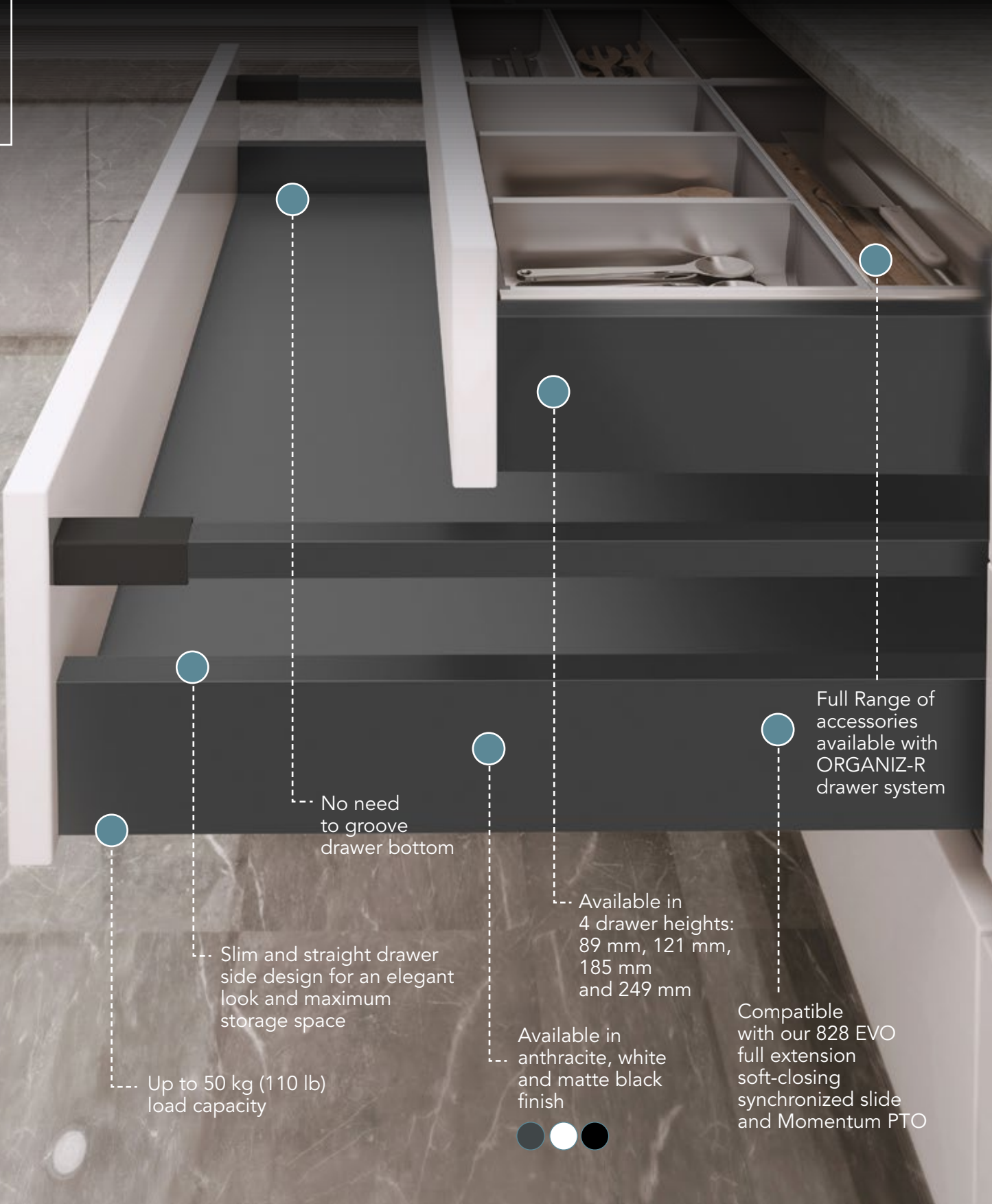

Up to 50 kg (110 lb) load capacity



Slim and straight drawer side design for an elegant look and maximum storage space



No need to groove drawer bottom



Available in anthracite, white and matte black finish



Available in 4 drawer heights: 89 mm, 121 mm, 185 mm and 249 mm



Compatible with our 828 EVO full extension soft-closing synchronized slide and Momentum PTO



Full Range of accessories available with ORGANIZ-R drawer system



Optimiz<sup>R</sup>



The OPTIMIZ-R drawer is compatible with 828 EVO slides (p. 40) and MOMENTUM push-to-open slides (p. 42).

| Drawer nominal length | Internal drawer depth | Min. internal cabinet depth |
|-----------------------|-----------------------|-----------------------------|
| 270 mm (10")          | 254 mm (10")          | 285 mm (11 1/4")            |
| 300 mm (12")          | 274 mm (10 13/16")    | 305 mm (12")                |
| 350 mm (14")          | 324 mm (12 3/4")      | 355 mm (14")                |
| 400 mm (16")          | 374 mm (14 3/4")      | 405 mm (15 15/16")          |
| 450 mm (18")          | 424 mm (16 11/16")    | 455 mm (17 15/16")          |
| 500 mm (20")          | 474 mm (18 11/16")    | 505 mm (19 7/8")            |
| 550 mm (22")          | 524 mm (20 5/8")      | 555 mm (21 7/8")            |
| 600 mm (24")          | 574 mm (22 9/16")     | 605 mm (23 13/16")          |
| 650 mm (26")          | 624 mm (22 9/16")     | 655 mm (25 13/16")          |



## Drawer sides

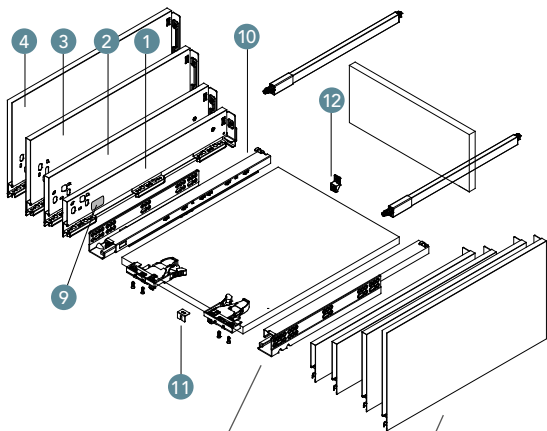

828 EVO series drawer slides  
(page 40)

The panels of the drawer include  
all covers and front supports  
with dowels.

Standard  
drawer front

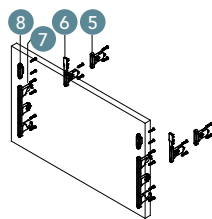

**H89**

**H121**

**H185**

**H249**

| Ref.                                  | Length       | Anthracite  | White       | Matte black |
|---------------------------------------|--------------|-------------|-------------|-------------|
| <b>Drawer height: 89 mm (3 1/2")</b>  |              |             |             |             |
| 1                                     | 270 mm (10") | 8088927100  | 808892730   | 8088927900  |
|                                       | 300 mm (12") | 8088930100  | 808893030   | 8088930900  |
|                                       | 350 mm (14") | 8088935100  | 808893530   | 8088935900  |
|                                       | 400 mm (16") | 8088940100  | 808894030   | 8088940900  |
|                                       | 450 mm (18") | 8088945100  | 808894530   | 8088945900  |
|                                       | 500 mm (20") | 8088950100  | 808895030   | 8088950900  |
|                                       | 550 mm (22") | 8088955100  | 808895530   | 8088955900  |
|                                       | 600 mm (24") | 8088960100  | 808896030   | 8088960900  |
| 650 mm (26")                          | 8088965100   | 808896530   | 8088965900  |             |
| <b>Drawer height: 121 mm (4 3/4")</b> |              |             |             |             |
| 2                                     | 270 mm (10") | 80812127100 | 8081212730  | 80812127900 |
|                                       | 300 mm (12") | 80812130100 | 8081213030  | 80812130900 |
|                                       | 350 mm (14") | 80812135100 | 8081213530  | 80812135900 |
|                                       | 400 mm (16") | 80812140100 | 8081214030  | 80812140900 |
|                                       | 450 mm (18") | 80812145100 | 8081214530  | 80812145900 |
|                                       | 500 mm (20") | 80812150100 | 8081215030  | 80812150900 |
|                                       | 550 mm (22") | 80812155100 | 8081215530  | 80812155900 |
|                                       | 600 mm (24") | 80812160100 | 8081216030  | 80812160900 |
| 650 mm (26")                          | 80812165100  | 8081216530  | 80812165900 |             |
| <b>Drawer height: 185 mm (7 1/4")</b> |              |             |             |             |
| 3                                     | 270 mm (10") | 80818527100 | 8081852730  | 80818527900 |
|                                       | 300 mm (12") | 80818530100 | 8081853030  | 80818530900 |
|                                       | 350 mm (14") | 80818535100 | 8081853530  | 80818535900 |
|                                       | 400 mm (16") | 80818540100 | 8081854030  | 80818540900 |
|                                       | 450 mm (18") | 80818545100 | 8081854530  | 80818545900 |
|                                       | 500 mm (20") | 80818550100 | 8081855030  | 80818550900 |
|                                       | 550 mm (22") | 80818555100 | 8081855530  | 80818555900 |
|                                       | 600 mm (24") | 80818560100 | 8081856030  | 80818560900 |
| 650 mm (26")                          | 80818565100  | 8081856530  | 80818565900 |             |
| <b>Drawer height: 249 mm (9 3/4")</b> |              |             |             |             |
| 4                                     | 450 mm (18") | 80824945100 | 80824945130 | 80824945900 |
|                                       | 500 mm (20") | 80824950100 | 80824950130 | 80824950900 |
|                                       | 550 mm (22") | 80824955100 | 80824955130 | 80824955900 |
|                                       | 600 mm (24") | 80824960100 | 80824960130 | 80824960900 |
|                                       | 650 mm (26") | 80824965100 | 80824965130 | 80824965900 |

## Optional parts

### Front brackets

| Ref. | Height          | Screw-on      | Expando dowel |
|------|-----------------|---------------|---------------|
| 5    | 89 mm (3 1/2")  | BP8088918912G | BP8088918932G |
| 6    | 121 mm (4 3/4") | BP80812112G   | BP80812132G   |
| 7    | 185 mm (7 1/4") | BP80818512G   | BP80818532G   |
| 8    | 249 mm (9 3/4") | -             | BP80824932G   |

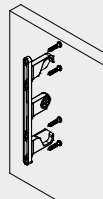

### Cover caps

| Ref. | Description            | Anthracite  | White      | Matte black |
|------|------------------------|-------------|------------|-------------|
| 9    | With Richelieu logo    | BP80802100E | BP8082030E | BP80803900E |
|      | Without Richelieu logo | 80801100    | 8080130    | 80801900    |

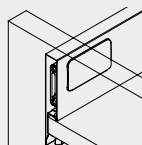

## Gallery rails

Create a drawer at your desired height using  
the OPTIMIZ-R rectangular front rail.

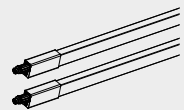

| Ref. | Height       | Anthracite     | White         | Matte black    |
|------|--------------|----------------|---------------|----------------|
| 10   | 270 mm (10") | 808LG1270MP106 | 808LG1270MP30 | 808LG1270MP900 |
|      | 300 mm (12") | 808LG1300MP106 | 808LG1300MP30 | 808LG1300MP900 |
|      | 350 mm (14") | 808LG1350MP106 | 808LG1350MP30 | 808LG1350MP900 |
|      | 400 mm (16") | 808LG1400MP106 | 808LG1400MP30 | 808LG1400MP900 |
|      | 450 mm (18") | 808LG1450MP106 | 808LG1450MP30 | 808LG1450MP900 |
|      | 500 mm (20") | 808LG1500MP106 | 808LG1500MP30 | 808LG1500MP900 |
|      | 600 mm (24") | 808LG1600MP106 | 808LG1600MP30 | 808LG1600MP900 |

## Additional brackets

\*Optional.  
Recommended for  
drawers 28" or wider.

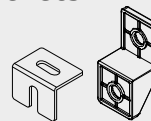

| Ref. No. | Description    |
|----------|----------------|
| 11       | 808JG160 Front |
| 12       | 808DBHDJ Rear  |

## Drilling templates



| No.       | Drawer height  |
|-----------|----------------|
| 808JIG185 | 185 mm         |
| 808JIG89  | 121 mm / 89 mm |



## Inner drawer components

### Front panels

(can be cut to size)



| Ref. | Length            | Anthracite  | White      | Matte black |
|------|-------------------|-------------|------------|-------------|
| 13   | 800 mm (31 1/2")  | 8081800100  | 808180030  | 8081800900  |
|      | 1200 mm (47 1/4") | 80811200100 | 8081120030 | 80811200900 |



### Front fixing brackets

| Ref. | Height          | Anthracite | White     | Matte black |
|------|-----------------|------------|-----------|-------------|
| 14   | 89 mm (3 1/2")  | 808891100  | 80889130  | 808891900   |
| 15   | 121 mm (4 3/4") | 8081211100 | 808121130 | 808121900   |
| 16   | 185 mm (7 1/4") | 8081851100 | 808185130 | 808185900   |

### Rectangular front rails

(can be cut to size)

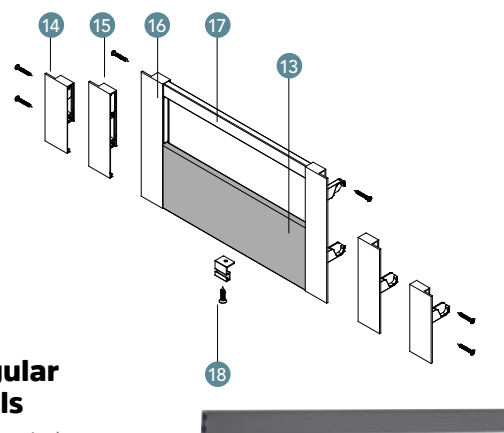

| Ref. | Length            | Anthracite | White     | Matte black |
|------|-------------------|------------|-----------|-------------|
| 17   | 800 mm (31 1/2")  | 808800100  | 80880030  | 808800900   |
|      | 1200 mm (47 1/4") | 8081200100 | 808120030 | 8081200900  |

### Bottom bracket

\*Optional. Recommended for drawers 28" or wider.

| Ref. No. |         |
|----------|---------|
| 18       | 808DB2G |



# Optimiz<sup>R</sup> PROGRAM

with smoked glass drawer sides





## Glass drawer sides: Effortless visibility meets sleek design

### OPTIMIZ-R smoked-glass drawer sides

Drawer height: 185 mm (7 1/4")

The kit includes the smoked-glass side panels, the cover caps and front fixing brackets.



| Ref. | Length       | Anthracite   | White        |
|------|--------------|--------------|--------------|
| 1    | 450 mm (18") | 80818545G100 | 80818545G030 |
|      | 500 mm (20") | 80818550G100 | 80818550G030 |
|      | 550 mm (22") | 80818555G100 | 80818555G030 |

### Front tempered glass inserts for OPTIMIZ-R

Tempered glass ensures safety and strength. It cannot be cut to size.

| Ref. | Internal width | Smoked-glass |
|------|----------------|--------------|
| 2    | 457 mm (18")   | 808185GL18   |
|      | 610 mm (24")   | 808185GL24   |
|      | 762 mm (30")   | 808185GL30   |
|      | 914 mm (36")   | 808185GL36   |



### Aluminum front inserts for OPTIMIZ-R glass drawer

Nominal length: 1,200 mm

| Ref. | White       | Anthracite   |
|------|-------------|--------------|
| 3    | 80811200G30 | 80811200G100 |



### Inner drawer front brackets for OPTIMIZ-R glass drawer

Drawer height: 185 mm (7 1/4")

| Ref. | White      | Anthracite  |
|------|------------|-------------|
| 4    | 8081851G30 | 8081851G100 |



# Decover

## Decorative covers

DECOVER is made from specially anodized aluminum, giving it a premium appearance and tactile quality. It fits securely around the sides of your OPTIMIZ-R drawer. Featuring an innovative clip-on system, DECOVER can be quickly installed on both new and existing OPTIMIZ-R drawers in just seconds. It undergoes extensive testing —hundreds of hours — during both the design and production phases. This ensures that DECOVER not only looks exceptional but is also durable and built to last.

FOR  
**OptimizR**

## Characteristics



**Recyclable materials**



**Quality**

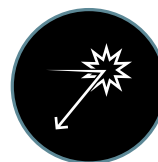

**Durability**



**Fast installation**

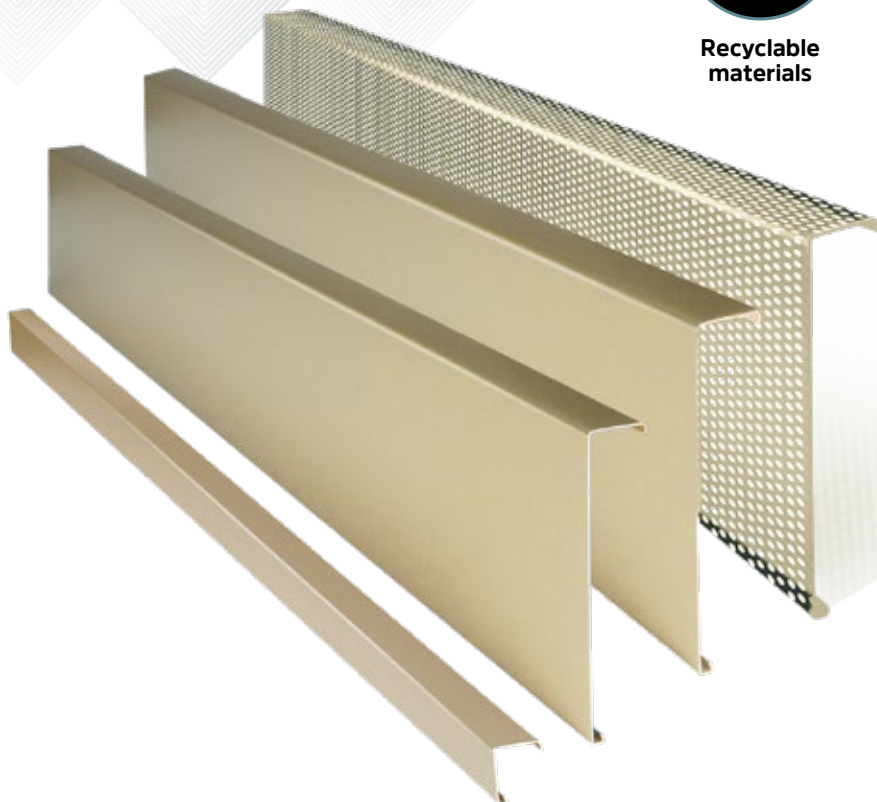

- + Entirely made of solid aluminum, cold-formed in Italy
- + Available in a length of 2200 mm and can be cut to size.
- + With a thickness of 0.5 mm, they do not interfere with the drawer's functionality

See technical details



## Available styles

DECOVER are tailor-made in three styles to fit the OPTIMIZ-R drawers.

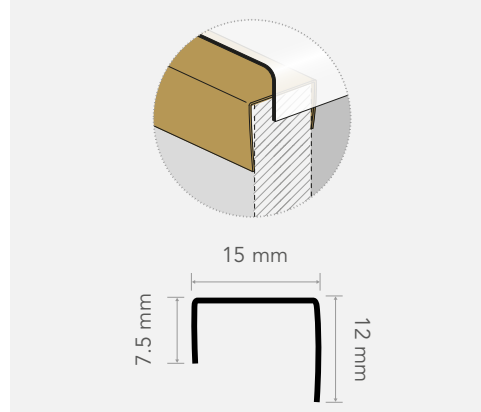
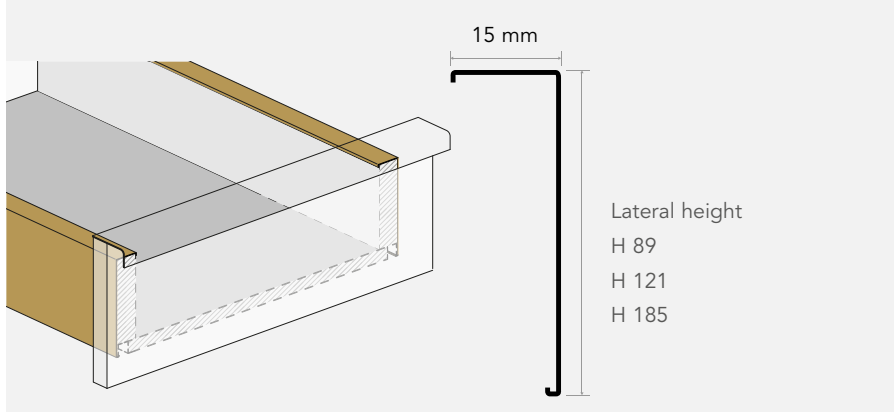
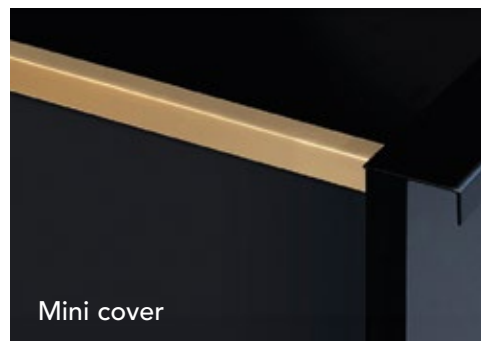
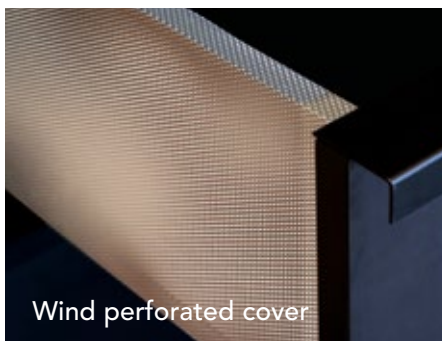
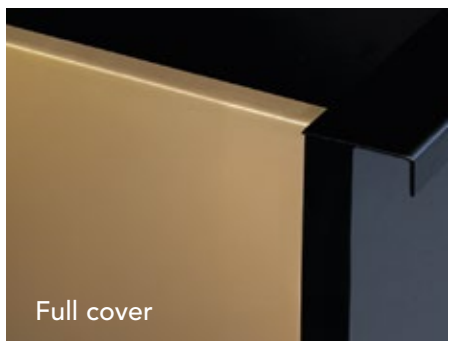



## Assembly

DECOVER can be installed in just a few simple steps, without the need for screws or glue. Get ready to impress in only few seconds per drawer!

1. Open the drawer fully

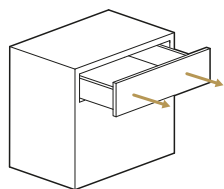

*NOTE: for certain types of drawers the sliding installation is necessary*

2. Attach the cover to the bottom edge of the drawer

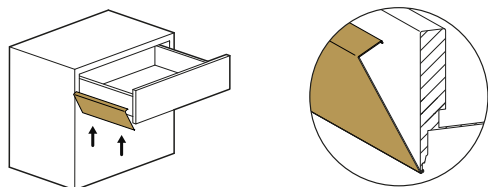

3. Fix the cover applying a gentle pressure

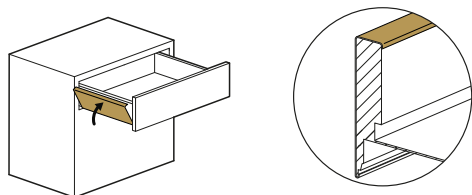

## Compatibility

Available for **OptimizR**

**H89 – H121 – H185**

**Finish:** Satin brass (160)

| Drawer style      | Full cover | Wind perforated cover |
|-------------------|------------|-----------------------|
| OPTIMIZ-R H89     | 808C89160  | 808CW89160            |
| OPTIMIZ-R H121    | 808C121160 | 808CW121160           |
| OPTIMIZ-R H185    | 808C185160 | 808CW185160           |
| <b>Mini cover</b> |            |                       |
|                   | 808CTOP160 |                       |



Few customization options, as sleek and flexible as these decorative aluminum covers are available on special order. Elevate your project with our exclusive special order finish options for

**OptimizR**



Decover Finish Samples  
No. 808DCK



| Finish              | COVER                 | Height             | Special order        |
|---------------------|-----------------------|--------------------|----------------------|
| Neutral Bronze (U8) | Full cover            | H89                | MS31709 - 808C89-U8  |
|                     |                       | H121               | MS31709 - 808C121-U8 |
|                     |                       | H185               | MS31709 - 808C185-U8 |
|                     | WIND perforated cover | H89                | MS31709-808CW89-U8   |
|                     |                       | H121               | MS31709-808CW121-U8  |
|                     |                       | H185               | MS31709-808CW185-U8  |
| Mini cover          | ALL                   | MS31709-808CTOP-U8 |                      |
| Inox (170)          | Full cover            | H89                | MS31709 - 808C89-U6  |
|                     |                       | H121               | MS31709 - 808C121-U6 |
|                     |                       | H185               | MS31709 - 808C185-U6 |
|                     | WIND perforated cover | H89                | MS31709-808CW89-U6   |
|                     |                       | H121               | MS31709-808CW121-U6  |
|                     |                       | H185               | MS31709-808CW185-U6  |
| Mini cover          | ALL                   | MS31709-808CTOP-U6 |                      |
| Verde (125)         | Full cover            | H89                | MS31709 - 808C89-U7  |
|                     |                       | H121               | MS31709 - 808C121-U7 |
|                     |                       | H185               | MS31709 - 808C185-U7 |
|                     | WIND perforated cover | H89                | MS31709-808CW89-U7   |
|                     |                       | H121               | MS31709-808CW121-U7  |
|                     |                       | H185               | MS31709-808CW185-U7  |
| Mini cover          | ALL                   | MS31709-808CTOP-U7 |                      |
| Copper (192)        | Full cover            | H89                | MS31709 - 808C89-RA  |
|                     |                       | H121               | MS31709 - 808C121-RA |
|                     |                       | H185               | MS31709 - 808C185-RA |
|                     | WIND perforated cover | H89                | MS31709-808CW89-RA   |
|                     |                       | H121               | MS31709-808CW121-RA  |
|                     |                       | H185               | MS31709-808CW185-RA  |
| Mini cover          | ALL                   | MS31709-808CTOP-RA |                      |



## ORGANIZ-R individual components

ORGANIZ-R's components allow you to create limitless custom organization solutions that fulfill your needs.



### 1 Side panels

Modular panels that can be joined together with ORGANIZ-R end connectors.



### 2 End connectors

For connecting side panels to create an infinite number of drawer storage solutions.

| Ref.                  | No.              | Length            | Finish          |
|-----------------------|------------------|-------------------|-----------------|
| <b>SIDE PANELS</b>    |                  |                   |                 |
| 1                     | 808SP450100      | 450 mm (18")      | Anthracite      |
|                       | 808SP450170      | 450 mm (18")      | Stainless steel |
|                       | 808SP500100      | 500 mm (20")      | Anthracite      |
|                       | 808SP500170      | 500 mm (20")      | Stainless steel |
|                       | 808SP550100      | 550 mm (22")      | Anthracite      |
|                       | 808SP550170      | 550 mm (22")      | Stainless steel |
| <b>END CONNECTORS</b> |                  |                   |                 |
| 2                     | 808EC88100       | 88 mm (3 7/16")   | Anthracite      |
|                       | 808EC88170       | 88 mm (3 7/16")   | Stainless steel |
|                       | 808EC176100      | 176 mm (6 15/16") | Anthracite      |
|                       | 808EC176170      | 176 mm (6 15/16") | Stainless steel |
|                       | 808EC264100      | 264 mm (10 3/8")  | Anthracite      |
| 808EC264170           | 264 mm (10 3/8") | Stainless steel   |                 |
| <b>CROSS DIVIDERS</b> |                  |                   |                 |
| 3                     | 808CD88100       | 88 mm (3 7/16")   | Anthracite      |
|                       | 808CD88170       | 88 mm (3 7/16")   | Stainless steel |
|                       | 808CD176100      | 176 mm (6 15/16") | Anthracite      |
|                       | 808CD176170      | 176 mm (6 15/16") | Stainless steel |
|                       | 808CD264100      | 264 mm (10 3/8")  | Anthracite      |
|                       | 808CD264170      | 264 mm (10 3/8")  | Stainless steel |
| <b>TRAYS</b>          |                  |                   |                 |
| 4                     | 808TR88100       | 88 mm (3 7/16")   | Stainless steel |
|                       | 808TR176100      | 176 mm (6 15/16") | Stainless steel |
|                       | 808TR264100      | 264 mm (10 3/8")  | Stainless steel |



### 3 Cross dividers

they are movable, they can be installed in any of the holes found on the side panels.



### 4 Trays

Versatile and durable, these trays are ideal for easily organizing your drawers.

## Starter kits without trays

Starter kits are the turnkey solution of the Organiz-R system. Don't quite meet your requirements? Simply add trays or panels.

### Included:

- 2 side panels (available in 500 mm or 550 mm depth)
- 2 end connectors
- 1 cross divider

| Ref.          | No.           | For drawer   | Finish          |
|---------------|---------------|--------------|-----------------|
| <b>NARROW</b> |               |              |                 |
| 1             | 808NKIT450100 | 450 mm (18") | Anthracite      |
|               | 808NKIT450170 | 450 mm (18") | Stainless steel |
|               | 808NKIT500100 | 500 mm (20") | Anthracite      |
|               | 808NKIT500170 | 500 mm (20") | Stainless steel |
|               | 808NKIT550100 | 550 mm (22") | Anthracite      |
|               | 808NKIT550170 | 550 mm (22") | Stainless steel |
| <b>MEDIUM</b> |               |              |                 |
| 2             | 808MKIT450100 | 450 mm (18") | Anthracite      |
|               | 808MKIT450170 | 450 mm (18") | Stainless steel |
|               | 808MKIT500100 | 500 mm (20") | Anthracite      |
|               | 808MKIT500170 | 500 mm (20") | Stainless steel |
|               | 808MKIT550100 | 550 mm (22") | Anthracite      |
|               | 808MKIT550170 | 550 mm (22") | Stainless steel |
| <b>WIDE</b>   |               |              |                 |
| 3             | 808WKIT450100 | 450 mm (18") | Anthracite      |
|               | 808WKIT450170 | 450 mm (18") | Stainless steel |
|               | 808WKIT500100 | 500 mm (20") | Anthracite      |
|               | 808WKIT500170 | 500 mm (20") | Stainless steel |
|               | 808WKIT550100 | 550 mm (22") | Anthracite      |
|               | 808WKIT550170 | 550 mm (22") | Stainless steel |

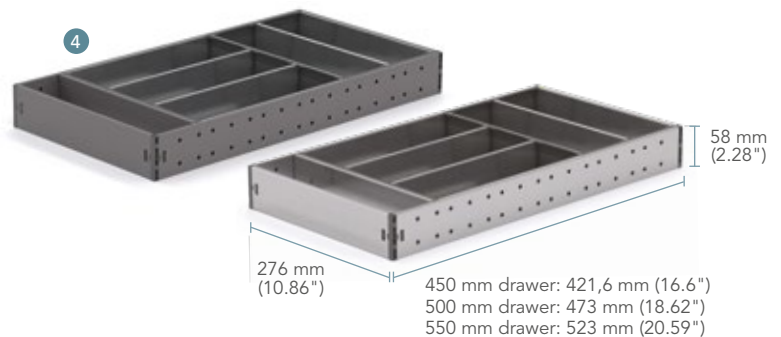
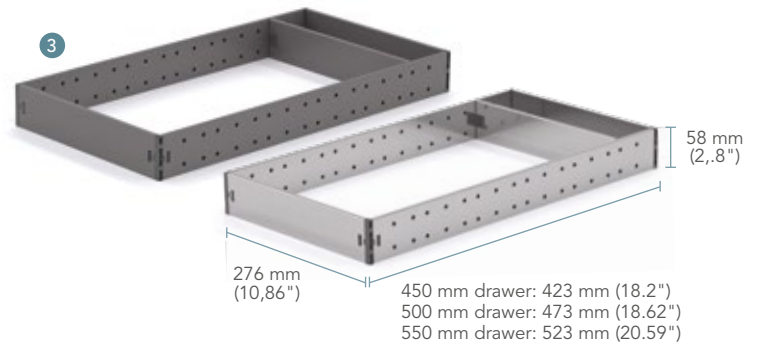
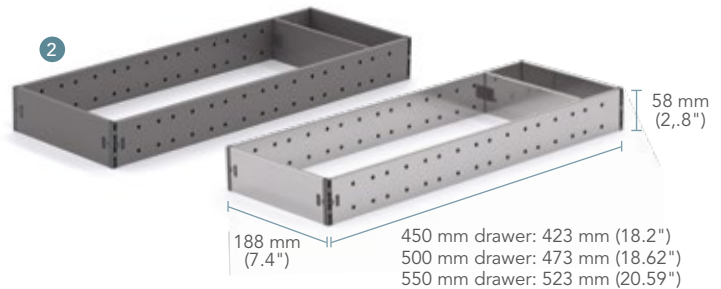
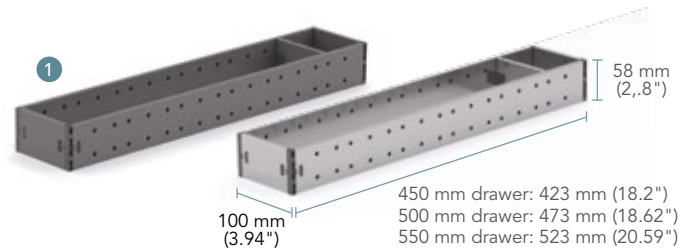

## Starter kits with trays

### Included:

- 2 side panels
- 2 end connectors
- 1 cross divider
- 5 trays

| Ref.           | No.           | For drawer   | Finish          |
|----------------|---------------|--------------|-----------------|
| <b>CUTLERY</b> |               |              |                 |
| 4              | 808CKIT450100 | 450 mm (18") | Anthracite      |
|                | 808CKIT450170 | 450 mm (18") | Stainless steel |
|                | 808CKIT500100 | 500 mm (20") | Anthracite      |
|                | 808CKIT500170 | 500 mm (20") | Stainless steel |
|                | 808CKIT550100 | 550 mm (22") | Anthracite      |
|                | 808CKIT550170 | 550 mm (22") | Stainless steel |

## Add-on products

### Fixing brackets

Some drawer dimensions are not standard, which can cause the organizer system to move every time you close or open the drawer. These easy-to-install fixing brackets are the perfect solution. The bracket kit includes two fixing brackets and two screws to fix the Organiz-R system to the bottom of the drawer.



No. 808BR2G

### Non-slip mat

Safeguards the bottoms of drawers and keeps the trays stable while opening or closing the drawer. The anthracite mat is an ideal match for the Organiz-R color palette and can be resized to any specific measurements to fit a drawer perfectly.

W x D: 43 1/4" x 23 5/8"



No. 6115212906



## Deep drawer solutions

The key to optimizing and organizing deep metal drawer storage is to determine what you want to store in a deep drawer and choose the storage solution that best suits your items and drawer space.

1

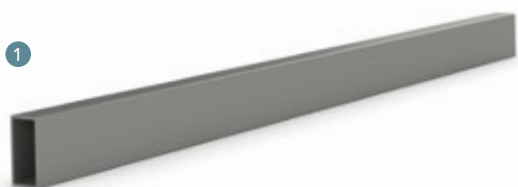

### Horizontal rail

ORGANIZ-R horizontal rails are made of aluminum and can be easily cut to size.

Length: 1,200 mm

2



### Cross rail connector

Designed to fit lateral gallery rail. The inside connector cushion is carefully designed to accommodate different layouts depending on the application.

3



### Lateral divider

The compact design of this divider allows for adding as many as required. Perfect for storing bottles, containers, and lids.

4



### Square partition divider

The finishing touch to the horizontal rail system, these dividers segment and separate the areas of your drawer storage.

| Ref.                     | No.      | Finish     |
|--------------------------|----------|------------|
| HORIZONTAL RAIL          |          |            |
| 1                        | 808HR100 | Anthracite |
|                          | 808HR30  | White      |
|                          | 808HR900 | Black      |
| CROSS RAIL CONNECTOR     |          |            |
| 2                        | 808AD100 | Anthracite |
|                          | 808AD30  | White      |
|                          | 808AD900 | Black      |
| LATERAL DIVIDER          |          |            |
| 3                        | 808LS100 | Anthracite |
|                          | 808LS30  | White      |
|                          | 808LS900 | Black      |
| SQUARE PARTITION DIVIDER |          |            |
| 4                        | 808RS100 | Anthracite |
|                          | 808RS30  | White      |
|                          | 808RS900 | Black      |

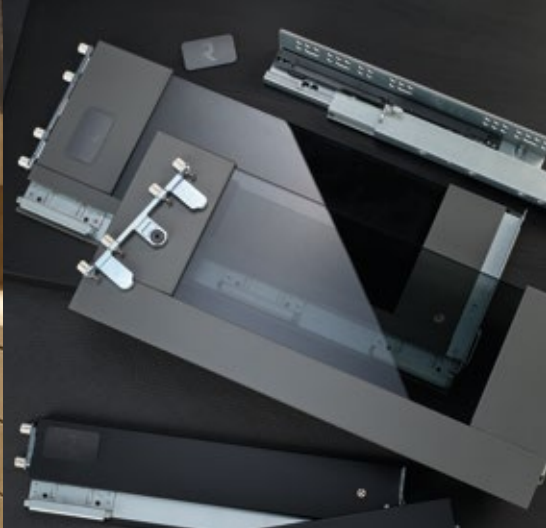
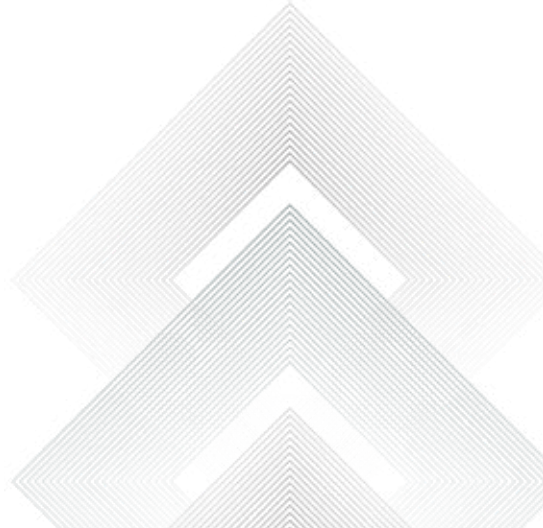

# SEBIOR

IT ALL STARTS WITH A DREAM

11001 258th Ct., Trevor, WI 53179

(262) 618-7010

[www.Sebior.com](http://www.Sebior.com)

