



SEBIOR
IT ALL STARTS WITH A DREAM

Fit Art

MODULAR SYSTEM FOR PANNELLING



Fit Art MODULAR SYSTEM FOR PANELLING

Fit Art is an innovative and versatile modular system that increases wall functionality in residential and commercial spaces.

Vertical standards and horizontal profiles can be combined with shelf supports, hangrails and shoe racks that can be arranged at any height.

VERTICAL STANDARDS

1. Vertical concealed standard for decorative panelling
2. Vertical double-slotted standard
3. Vertical finishing standard

HORIZONTAL PROFILES

4. Horizontal customizable profile
5. Horizontal finishing profile

SUPPORTS FOR CUSTOMIZABLE HORIZONTAL PROFILES

6. Supports for wood shelves
7. Not shown
8. Supports for hangers

SUPPORTS FOR VERTICAL DOUBLE-SLOTTED STANDARDS

9. Supports for wood shelves
10. Supports for hangers
11. Shoe rack
12. Clothes hanging rail



OPTIMIZE AND CUSTOMIZE VERTICAL AND HORIZONTAL WALL FUNCTIONALITY WITH SPECIALIZED ACCESSORIES FOR ENDLESS DESIGN POSSIBILITIES.

The structure can be visible or invisible depending on the type of profile used. Vertical standards can be screwed directly into wall studs or existing drywall and accommodate panels 3/4" to 1 1/8" (19 to 30 mm) thick. Horizontal profiles can accommodate panels up to 3/4" (19 mm) thick. Once the structure is in place, the panels can easily be removed or changed for updates and repairs.

Suited for wood panelling and materials such as stone, composite wall cladding, sandwich panelling or any other material that can be screwed in directly.

Ideal for residential & commercial applications:

- DECORATIVE WALL PANELLING
- OFFICE FURNITURE & PARTITIONS
- ENTERTAINMENT & WALL UNITS
- CLOSETS



STANDARDS & PROFILES



1 VERTICAL CONCEALED STANDARD FOR DECORATIVE PANELLING

Designed for decorative wall panelling with a completely frameless and floating appearance. Panels hook easily into eyelets for fast assembly.

- Use templates for flush panel assembly (see no. 17)
- No tooling required for panels
- For any kind of panel material and thickness
- Material: Steel

No.	Width	Length
62NB028862G	2 3/8" (60 mm)	9'-5 1/2" (2.9 m)

Use collar screws and spacers to adjust for different panel thicknesses (see no. 13).

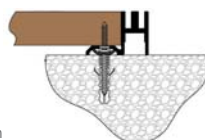
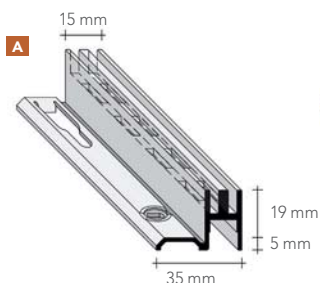
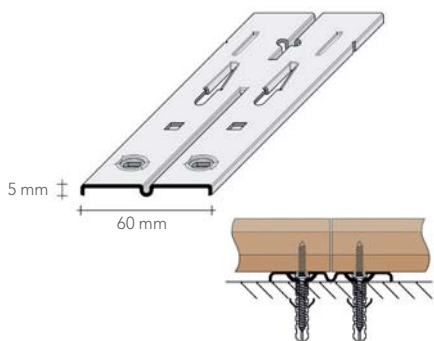

2 VERTICAL DOUBLE-SLOTTED STANDARDS

To be used as weight-bearing supports for shelves and accessories.

- For panels 3/4" (19 mm) (flush fit) to 1 1/8" (30 mm) thick
- Length: 8'-3" (2.5 m)
- Material: Anodized aluminum
- Finish: Satin aluminum

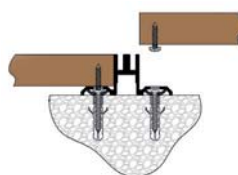
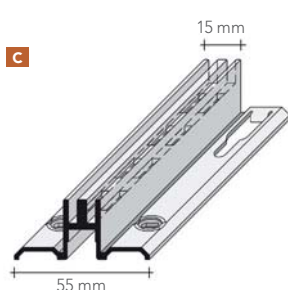
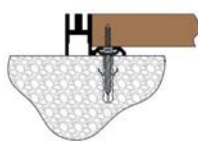
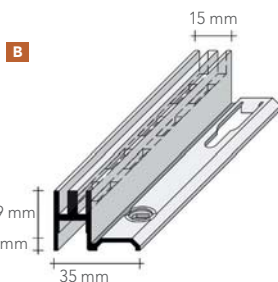

No.	Position	Width
A 62NB325DX10	Right	1 3/8" (35 mm)
B 62NB325SX10	Left	1 3/8" (35 mm)
C 62NB2253110	Central	2 3/16" (55 mm)



STANDARDS & PROFILES



3 VERTICAL FINISHING STANDARDS

Provides a decorative finish for the ends of walls, between panels and inside/outside corners.

- For panels 3/4" (19 mm) to 1 1/8" (30 mm) thick
- Length: 9'-10" (3 m)
- Material: Anodized aluminum
- Finish: Satin aluminum

No.	Position	Width
A 62NB630DX10	Right	1" (25 mm)
B 62NB630SX10	Left	1" (25 mm)
C 62NB8301210	Central	1 7/8" (47 mm)
D 62NB9301210	Corner	2 1/4" (58 mm)

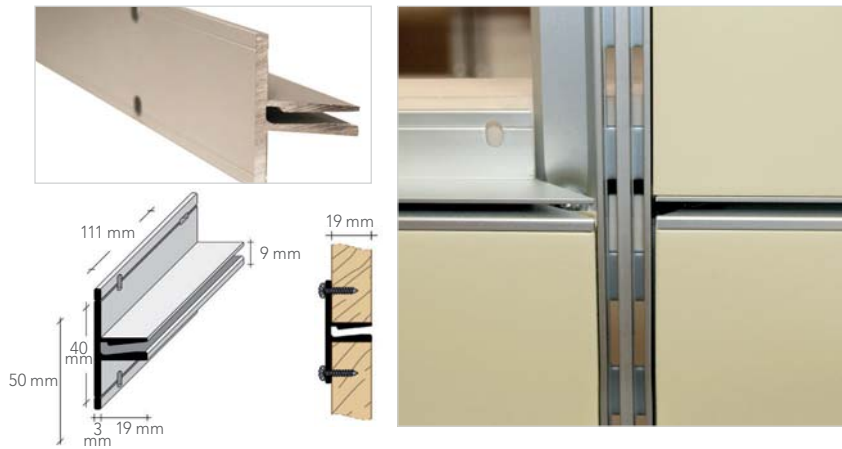

4 HORIZONTAL CUSTOMIZABLE PROFILE

To be used to support shelves and accessories.

- For panels 3/4" (19 mm) thick
- Length: 9'-10" (3 m)
- Material: Anodized aluminum
- Finish: Satin aluminum

No.	Position	Width
62FMH301210	Central	2" (50 mm)



5 HORIZONTAL FINISHING PROFILES

Provides a decorative finish in between rows of panels or at the top.

- For panels 3/4" (19 mm) thick
- Length: 9'-10" (3 m)
- Material: Anodized aluminum
- Finish: Satin aluminum

No.	Position	Width
A 62FM8301210	Central	1 7/16" (36 mm)
B 62FM6301210	Lateral finishing	1 1/16" (17 mm)

SUPPORTS FOR CUSTOMIZABLE HORIZONTAL PROFILES

6 SUPPORTS FOR WOOD SHELVES



UNDERMOUNT SHELF SUPPORT

- For 7/8" (22 mm) thick wood shelves
- Load capacity: 33 lb (15 kg) per pair
- Material: Anodized aluminum
- Finish: Satin aluminum

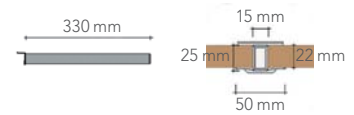

No.	Position	Option	Length
6222HC33010	Central	Without hangrail	13" (330 mm)
6222HC33A10		For hangrail *	
6222HD33010	Right	Without hangrail	
6222HD33A10		For hangrail *	
6222HS33010	Left	Without hangrail	
6222HS33A10		For hangrail *	

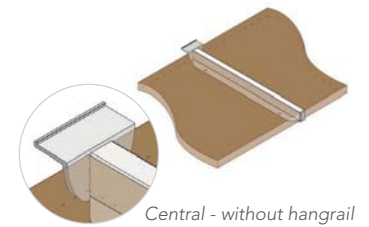

*See clothes hanging rail on page 9 for more details



UNIT FIXING SUPPORT

- Can be cut to size
- Drill through into shelf
- Load capacity is optimal if supports are used for the whole length and depth of the shelf
- Material: Anodized aluminum
- Finish: Satin aluminum

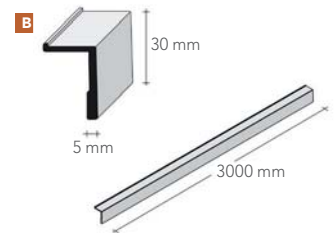

No.	Length
B 62H30300010	9'-10" (3 m)
C 62HS3300010*	9'-10" (3 m)

* with flange

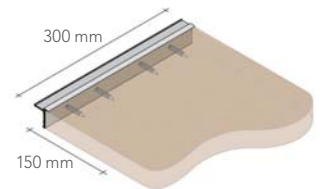
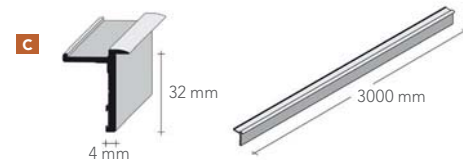

PRE-DRILLED SUPPORT WITH CONCEALED STEMS

- For 1 1/8" (30 mm) thick wood shelves
- For deeper shelves and more support
- Load capacity is optimal if supports are used for the whole length and depth of the shelf
- Material: Anodized aluminum
- Finish: Satin aluminum

No.	Length
62HS3CP0310	11 3/4" (300 mm)
62HS3CP0610	23 5/8" (600 mm)
62HS3CP0910	35 7/16" (900 mm)

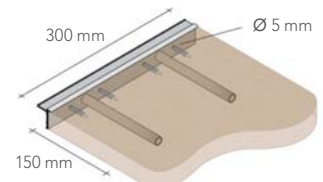
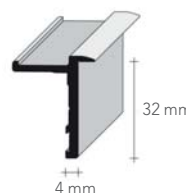

SUPPORTS FOR CUSTOMIZABLE HORIZONTAL PROFILES

7 SUPPORT FOR GLASS SHELVES

- For 5/16" (8 mm) thick glass shelves
- Maximum glass shelf width: 15 3/4" (400 mm)
- Load capacity is optimal if supports are used for the whole length of the shelf
- Material: Anodized aluminum
- Finish: Satin aluminum

No.	Length
62HV8G30010	9'-10" (3 m)

Finishing end caps

- Material: Plastic
- Finish: Satin nickel

No.	Position
62CAPHV8D185	Right
62CAPHV8S185	Left

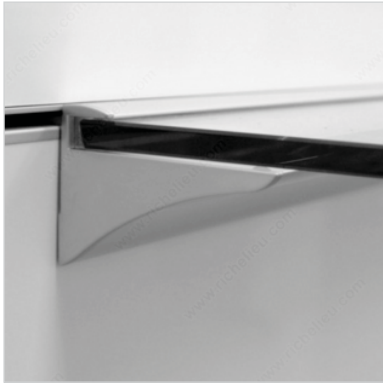
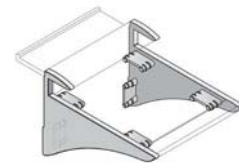
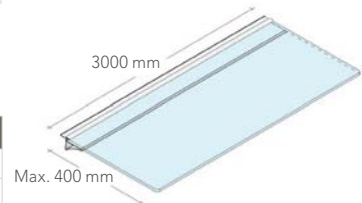
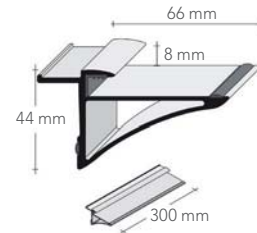

8 SUPPORTS FOR HANGERS

A. SUPPORT WITH PINS

- Inclined 35° oval support with pins to stop clothes hangers
- Material: Steel
- Finish: Satin nickel

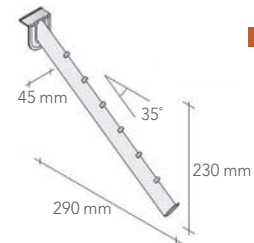

B. SUPPORT WITH GASKET AND RAISED END CAP

- Material: Anodized aluminum
- Finish: Satin aluminum

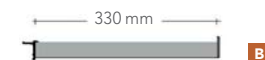
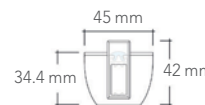

C. HANGER SUPPORT

- Tubular support for frontal displays with aluminum semi-elliptic base and end cap
- ø 12 mm
- Material: Anodized aluminum
- Finish: Satin aluminum

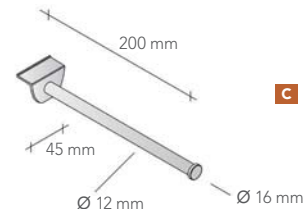

No.	Length	Load capacity
A 62TOHIN07185	11 3/8" (290 mm)	55 lb (25 kg)
B 6228H033510	13" (330 mm)	39 lb (18 kg)
C 62SHT122010	7 7/8" (200 mm)	17 lb (8 kg)

SUPPORTS FOR VERTICAL DOUBLE-SLOTTED STANDARDS



A

9 SUPPORTS FOR WOOD SHELVES

DOUBLE-INSERT MONO SUPPORT

- For 3/4" (19 mm) thick wood shelves
- Material: Anodized aluminum
- Finish: Satin aluminum

No.	Length	Load capacity
62MCT026010	10 1/4" (260 mm)	110 lb (50 kg)
62MCT019010	7 15/32" (190 mm)	132 lb (60 kg)

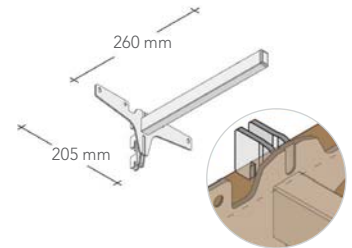

B

UNDERMOUNT DOUBLE-INSERT SUPPORT

- For 7/8" (22 mm) thick wood shelves
- Load capacity: 132 lb (60 kg) per pair
- Material: Anodized aluminum
- Finish: Satin aluminum

No.	Position	Option	Length
6222DC40010	Central	Without hangrail	15 3/4" (400 mm)
6222DC40A10		For hangrail *	
6222DD40010	Right	Without hangrail	
6222DD40A10		For hangrail *	
6222DS40010	Left	Without hangrail	
6222DS40A10		For hangrail *	

*See hangrail on page 9 for more details

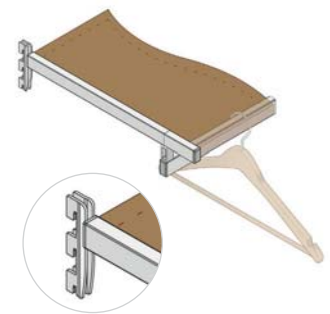

C

UNDERMOUNT SINGLE-INSERT SUPPORT

- For 7/8" (22 mm) thick wood shelves
- Load capacity: 66 lb (30 kg) per pair
- Material: Anodized aluminum
- Finish: Satin aluminum

No.	Position	Option	Length
6222LD40010	Right	Without hangrail	15 3/4" (400 mm)
6222LD40A10		For hangrail *	
6222LS40010	Left	Without hangrail	
6222LS40A10		For hangrail *	

*See hangrail on page 9 for more details

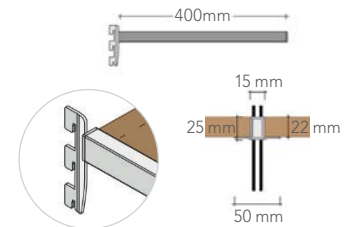

D

SINGLE-INSERT SUPPORT FOR SIDE-MILLED WOOD SHELF

- For 3/4" (19 mm) thick wood shelves
- Secure shelves with inserts (see no. 20)
- Load capacity: 88 lb (40 kg) per pair
- Material: Anodized aluminum
- Finish: Satin aluminum

No.	Position	Length
62T19DX3510	Right	14 3/8" (365 mm)
62T19DX4510		18 3/8" (467 mm)
62T19SX3510	Left	14 3/8" (365 mm)
62T19SX4510		18 3/8" (467 mm)

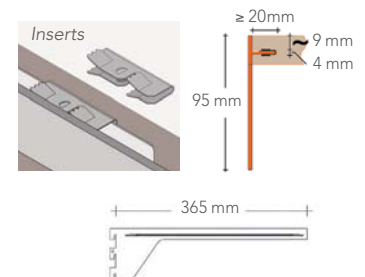

10 SUPPORTS FOR HANGERS

DOUBLE-INSERT SUPPORT WITH PINS

- Inclined 35° rectangular support with pins to stop clothes hangers
- Material: Anodized aluminum
- Finish: Satin aluminum

No.	Length	Load capacity
6228DIN0310	7 3/32" (180 mm)	110 lb (50 kg)
6228DIN0610	13 3/8" (340 mm)	132 lb (60 kg)

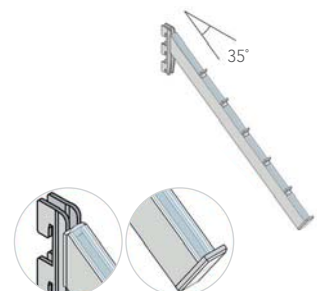

SHOE RACK & HANGRAIL



11 SHOE RACK

Supports

- Material: Anodized aluminum
- Finish: Satin aluminum

No.	Position	Length	Load capacity
62SKADX0310	Right	9 5/16" (236 mm)	11 lb (5 kg)
62SKASX0310	Left	(236 mm)	

Tube

- Material: Anodized aluminum
- Finish: Satin aluminum

No.	Ø	Length
62T12300010	12 mm	9'-10" (3 m)

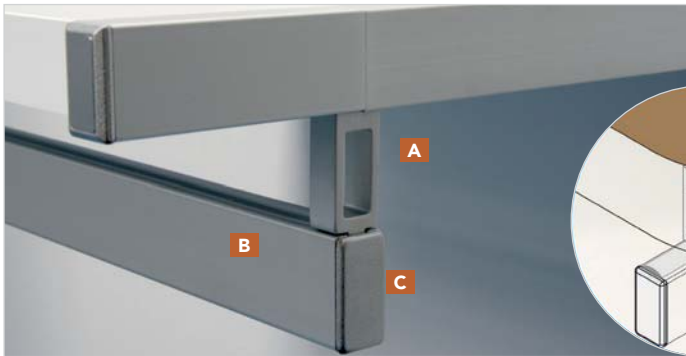
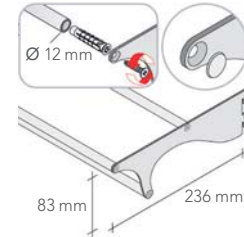

12 HANGRAIL

- Can be used with the UNDERMOUNT SHELF SUPPORT and UNDERMOUNT SINGLE-INSERT and DOUBLE-INSERT SHELF SUPPORTS



RECTANGULAR HANGRAIL SUPPORT

- To be fixed to a pre-drilled wood shelf using M5 screws (not included) – hole diameter: 5 mm
- Material: Anodized aluminum
- Finish: Satin aluminum

No.	Height
62R30INCA10	1 3/8" (35 mm)



RECTANGULAR HANGRAIL

- Material: Anodized aluminum
- Finish: Satin aluminum

No.	Length
62R30300010	9'-10" (3 m)



END CAP FOR RECTANGULAR HANGRAIL

- Material: Steel
- Finish: Satin nickel

No.	
62R30TMF1185	Sold by unit



TRANSPARENT GASKET FOR RECTANGULAR HANGRAIL

No.	Length
62G3012MT11	47 1/4" (1.2 m)



HANGRAIL CONNECTOR

- Inner joint rectangular hangrail connector
- Material: Steel

No.	
62GNTR3022G	

ACCESSORIES



A

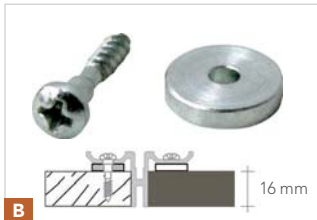

B

13 COLLAR SCREW WITH SPACER

· For adjusting to different panel thicknesses

No.	Panel thickness
A 62NBAVS102G	13/32" (10 mm)
B 62NBAVS162G	5/8" (16 mm)



No.
62NBATULL2G

14 SPECIAL DRIVE BIT WITH ADJUSTABLE STOP

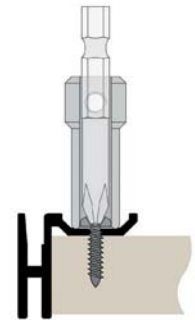

15 FIXING SCREWS



No.	Length
62NBAV1002G	5/8" (16 mm)



16 FINISHING GASKET

· For VERTICAL SLOTTED STANDARD

No.	Color
62GRN10MT100	Gray
62GRN10MT90	Black

17 TEMPLATE FOR FLUSH PANEL ASSEMBLY

· For screw placement on the back of the panel
· For flush panel assembly using VERTICAL CONCEALED STANDARD



No.
62NBA6DMF2G



ACCESSORIES



BACK OF PANEL

18 PANEL ASSEMBLY PLATE

- For the HORIZONTAL CUSTOMIZABLE PROFILE on long spans
- Material: Steel

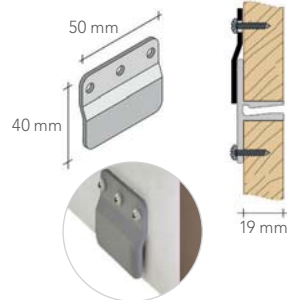

No.	Length
62PSTFMH12G	2" (50 mm)



19 BLISTER WIRE SUPPORT

- For the HORIZONTAL CUSTOMIZABLE PROFILE
- For retail applications
- Load capacity: 8 lb (4 kg)

No.	Length
62SHFPB20185	7 7/8" (200 mm)



20 INSERT FOR SIDE-MILLED WOOD SHELF

- Secures wood shelves in place
- Finish: Stainless steel

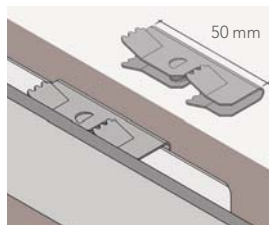

No.	Length
62CAVCLIP170	2" (50 mm)



21 TRANSPARENT REAR GASKET

- Protects the surface of the panel

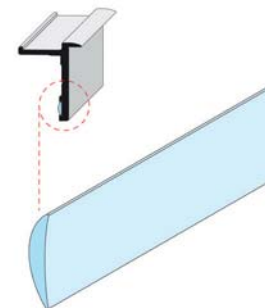

No.	Length
62MZN6X15311	9' 10" (3 m)



22 HOLDING PLATE

- For fixing a unit to the VERTICAL SLOTTED PROFILE
- Depth: 2" x 2 3/16" (50 x 55 mm)
- Material: Steel

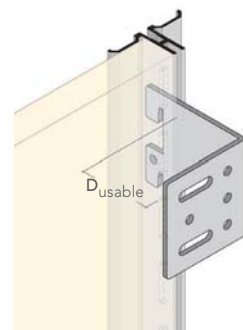

No.	Position
62PAKDX102G	Right
62PAKSX102G	Left

*D_{usable} = Usable depth between insert point and back part of the bracket



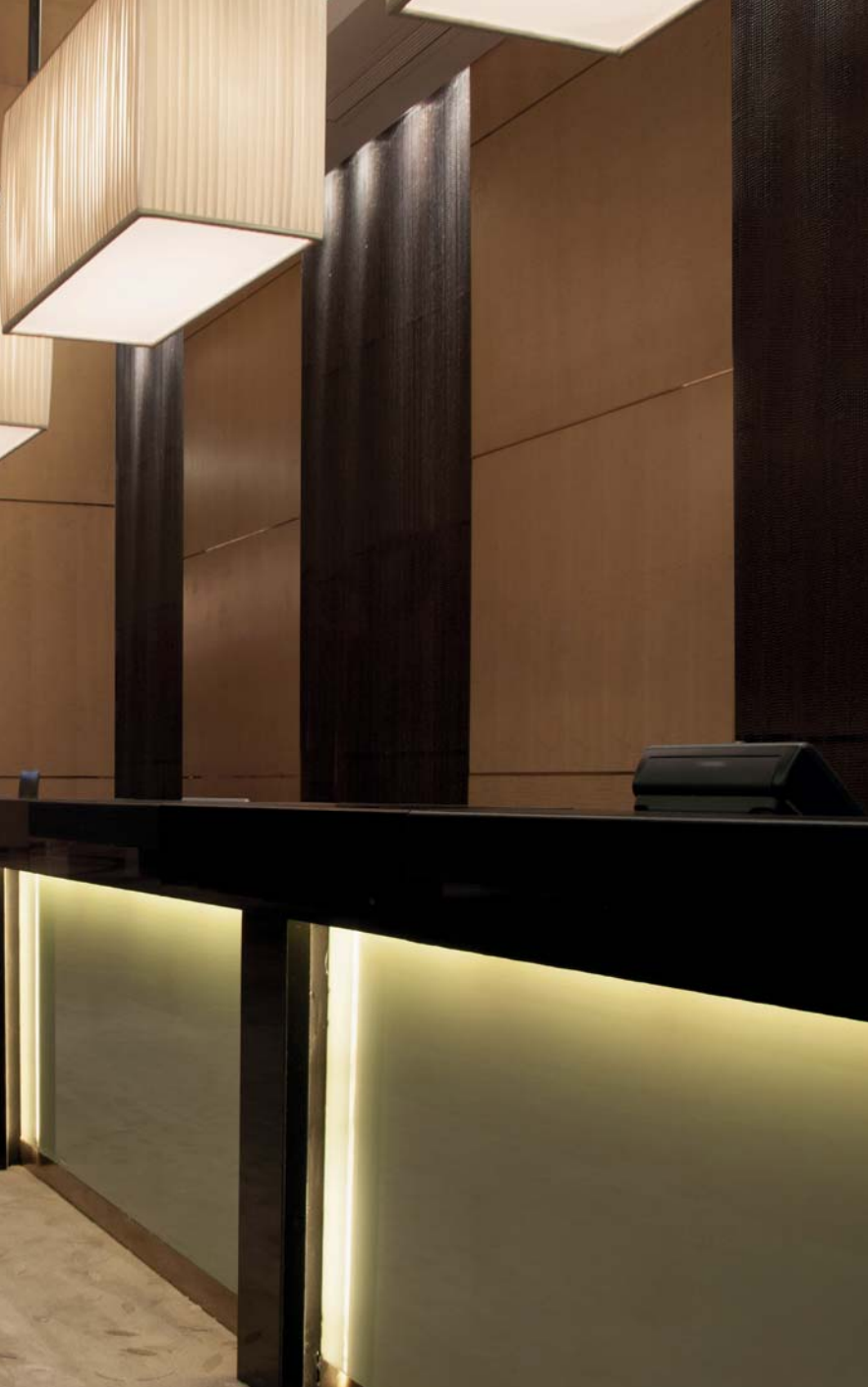

SEBIOR

IT ALL STARTS WITH A DREAM

11001 258th Ct., Trevor, WI 53179

PH:(262) 618-7010

www.Sebior.com